

Operation & Maintenance Instructions

400 Series Power Controller



Contents

Preface	4
Section 1: Safety Precautions	
Hazards and Other Symbols	5
Warnings and Cautions	6
Conditions of Acceptability	7
Section 2: System Overview	
Application	8
Power	8
Charging	8
Monitoring	8
Buzzer	8
Communication/Software	9-11
Intended Use	12
Section 3: System Description	
Enclosure	12
Power Supplies	12
Motherboard	12
AC Module (Series 451 only)	12
Remote Display	13
Temperature Sensors	13
Fan Control	13
State of Health	13
Section 4: System Connection	
Description and Location of Parts	14-15
Diagram of Connections	16
AC Power Input	17
Batteries	17
Battery Connection Diagrams	17-18
Temperature Sensors	18-19
Host Computer	19
Small PCs and All-in-one PCs	19
Laptop	19
Remote Display	19
DC/AC Output Power	19-20
Thermal Sensors	20

Contents

Section 5: Installation of Software

Host PC Software	20
------------------	----

Section 6: Initial Testing and Error Conditions

Remote Display	21
Battery	21
Main User's Interface	21
AC Power	21
System Communication with the Host	21
Sleep Mode	22
Error Conditions	22
Over Temperature	22
Overload	23
Charger Time Out or Bad Battery	23
System Reset	23

Section 7: Operation

Turn On	24
Sleep Mode	24
System Set Up	25
401 Series Setup	26
GUI Setup	27
Email Setup	28
Test Email	29
Sleep Mode Activation	29
Buzzer	29
Upload EEPROM Data	30
CartTrac (Optional)	30
Charging	31-32
Discharging	32-33

Section 8: Field Diagnostics

System Status at a Glance	34
Advanced Functions Description	35
Pull Down Menus	35
Gauge and LED Indicators	36
Thermal Sensors	36
Battery Power	36
Load Power	36
AC Module Enable	36
System Diagnostics	37
Event Log Screen	38

Contents

Section 9: Maintenance	
Maintenance Screen	39
General Maintenance	40
Battery Maintenance	40
Section 10: Potential Hazards, Interference and Avoidance	41
Section 11: System Specifications	
Classification	42
Identification, Marking and Documents	42
Input	42
Input/Output: DC Battery	42
Output: AC & DC Load	43
Output: Fan	43
Output: Temp Sensors	43
Input/Output: USB	43
Output: Remote Display	43
General	43
Environmental	43
Mechanical	44
Battery Profiles	44
Features	44
Section 12: TUV Certification Statement	45
Appendix A: Dimensional and Mounting Information	45
Warranty	46

Preface

IMPORTANT, PLEASE READ CAREFULLY

Thank you for your purchase with Amico Accessories Inc.

This unit is designed for long lasting performance, provided that the end user complies with assembly and maintenance procedures. This Manual is your guide to ensure that you get the best performance out of the equipment. Amico Accessories Inc. is not responsible for any damage as a result of (but not limited to) abuse and other problems that may be a direct or indirect result of failure to comply with the instructions provided in this manual.

Please Note These Key Words and Symbols:



WARNING

Steps where extra care should be taken to prevent injuries and damage.



NOTE

Steps that point out helpful information.









Medical Facility Responsibilities

Preventive maintenance checks must be performed regularly to maintain the quality and performance of this product. Any parts that may be broken, missing, worn, distorted or contaminated in any way should not be used and all affected parts should be replaced immediately. Should the necessity of any repair be suspected, please contact your local distributor or call 1.877.264.2697.

Section 1: Safety Precautions

Hazards and Other Symbols

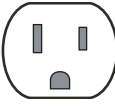
The following symbols are relevant to either this manual or the Power System.

SYMBOL	TITLE	DESCRIPTION
	ALTERNATING CURRENT	
	DIRECT CURRENT	
	ATTENTION	Attention: consult ACCOMPANYING DOCUMENTS
	ELECTRICAL HAZARD	Indicates an electrical hazard may exist
	Follow Operating Instructions Note: On ME EQUIPMENT "Follow instructions for use".	
	Low Battery	Symbol used for indicating low battery on the remote display device.
	Powered by DC	Symbol used for indicating that the Power System is currently powered by DC [battery]. Used on the remote display device.
	Powered by AC	Symbol used for indicating that the Power System is currently powered by AC [wall power]. Used on the remote display device.
	Earth Ground	

Section 1: Safety Precautions

Warnings and Cautions





All operating instructions should be thoroughly reviewed prior to the use of the system. Warnings and instructions should be followed while installing or operating the Power System.

Definitions:





CAUTION: Indicates a hazardous situation, which if not avoided, may result in minor or moderate injury or product or property damage.

WARNING: Indicates a potentially hazardous situation, which, if not avoided, could result in serious injury or death.

CAUTION:

-  The AC power conductors must be assembled to a certified plug assembly by a qualified technician. For compliance to the safety and EMC specifications, the plug assembly must meet the requirements dictated within this operations manual.
-  Appropriate airflow is required at both the inlet and exhaust vents of the Power System. Adequate open area cross section to the Power System should be provided for room ambient air to the inlet and outlet of the Power System. There should be no blockage of air around the fans and vented ends of the power supply. Fan guards are recommended to protect the function of the external fans and to prevent dust accumulation. Fan guards are recommended to be checked and cleaned occasionally to provide optimal air flow.

WARNING:

-  DO NOT allow untrained technicians to install, modify or otherwise handle this equipment. This equipment is intended to be installed into an Original Equipment Manufacturer's product in a controlled setting with precise work instructions and trained assembly personnel.
-  DO NOT operate the Power System without the covers completely installed and the connectors attached properly. The covers provide safety from potentially dangerous voltages.
-  Do not connect or disconnect the Power System while power is applied. Do not open or in any other manner change the access to the internal portion of the Power System while power is applied.
-  Do not allow the Power System to come in contact with fluids. Do not operate the Power System if wet.

Section 1: Safety Precautions

Conditions of Acceptability

⚠ CAUTION: When installed in an end-product, consideration must be given to the following:

- Appropriate airflow is required for this unit to operate correctly under normal and fault conditions. Suitable spacing should be provided for the fans and vented ends to allow air flow in and out of the Power System. When installing the Power System, the cubic area needed for air flow should be taken in consideration and thermal testing must be performed as part of the end-product acceptance. There should be no barriers to the fans and the vents of the Power System.
- Suitable fire enclosure must be provided as part of the end-use system investigation. The component shall be installed in compliance with enclosure, mounting, packing, casualty and segregation requirements of end-use system requirements.
- Leakage testing must be performed on end-use system.
- IEC 60601-1-4 not performed and must be considered for end-use system.
- Clause 15b limitation of Voltage and/or Energy must be performed on end-use system.
- The AC Line input cable and IEC connector are supplied by the user. Although not strictly required, it is strongly recommended for additional protection that a fused IEC Input Module (or other external fuse arrangement) is used with the Power System. The recommended fuse type is 10 A 250 VAC. Both Line and Neutral conductors should be fused. The AC voltage input earth ground complies with bonding impedance requirements when it is attached to a standard AC wall outlet. There is no required or provided earth ground bonding when the end-use system is mobile.
- DC output short circuit and reverse polarity testing shall be considered on end use equipment.
- The DC voltage output cables are supplied by the user. The DC outputs from the Power System do not need to be fused due to internal current limiting. If the user wishes to install fuse(s) for additional protection, fuse type and sizing should be based on end-use requirements.
- The Battery Cable is supplied by the user. There is no requirement for fusing the Battery Cable since the Power System includes a replaceable internal fuse. If external fusing is desired, careful consideration should be given to fuse specifications for end-use requirements.
- Equipment has not been evaluated as AP/APG equipment. Must be considered as part of the end system equipment.
- Component shall be properly bonded to the main protective earth termination in the end-use system and comply with end-system bonding impedance requirements when it is attached to a standard AC wall outlet. There is no required or provided earth ground bonding when the end-use system is mobile.
- Complies with requirements for US for outside the patient environment. For use within the patient environment, evaluation must be performed as part of end system equipment.

This product contains electrical components. Observe local, state and federal guidelines for proper disposal. The end product manufacturer should be contacted for procedures. For further information on disposal, contact Amico Accessories Inc. at 1.877.264.2697.



Section 2: System Overview

Application

The 400 Series DC Controller is a Medical Grade Power Management System designed for use with both Sealed Lead Acid [SLA] Absorbent Glass Matt [AGM] and Lithium Iron Phosphate Batteries in Mobile Point of Care [MPOC] products for Hospitals and Long Term Health Care facilities. The product uses microprocessor based technology for intelligent charging, reconditioning, state of charge monitoring and DC power control. It is designed, manufactured and certified to EN 60601 Medical Safety Standards. There are two models in the 400 Series: Model 401 and Model 451. The Model 401 provides 19.5 V, 12 V, and 5 V DC outputs. The Model 451 provides the same DC outputs as the Model 401 but also includes a 115 VAC output. The hybrid design of the Model 451 provides True Sine Wave AC output together with multiple regulated DC outputs to power any combination of equipment, without the need for external converters. Both models can be customized to user needs and other battery chemistries can be included with simple firmware upgrades.

Power

The 400 Series DC Controller uniquely combines the “By-Pass” feature of AC Systems with the high efficiency and long run times of traditional DC Systems. It uses an automatic transfer of load to ensure smooth uninterrupted supply switching from AC Wall power to DC Battery power.

The 400 Series DC Controller has the capability of powering multiple DC and AC devices (AC with Model 451 only) up to a combined load of 200 watts while simultaneously charging the battery.

Charging

The 400 Series DC Controller is optimized for battery capacities in the range of 10 Ah to 100 Ah, and has the capability to charge at up to 25 Amps. It uses an intelligent multi-stage charging algorithm to adhere to the battery manufacturer’s specifications and maximize battery life while maintaining safe operating conditions. Presently there are numerous preset charging profiles for both Lithium Iron Phosphate and Sealed Lead Acid batteries. Other battery chemistry profiles may be added in the field with a simple firmware upgrade.

Monitoring

The system has an on-board microprocessor that monitors multiple sensors for use with the State of Charge [SOC] predictions; DC voltage, DC current, ambient temperature, battery temperature, total charge, discharge amp hours since activation and battery experience. A key monitoring feature is Event Logging which logs key information each time the battery experiences a specific event. Using the power system’s memory, up to 2000 events can be logged and used for diagnostics and maintenance scheduling. Using the host system’s memory, the total number of events is limited only by the host system’s available storage capacity.

Buzzer

The buzzer is audible at a frequency of 2.4 kilohertz nominal at an audible intensity of typically 92 decibels at 10 centimeters. The buzzer may be enabled or disabled by the user. If disabled, the buzzer will not sound for ANY circumstance. The buzzer, if enabled, will notify the user if the battery power goes below a pre-established state of charge voltage threshold indicating an imminent need for charging and/or discontinuing computer usage.

Section 2: System Overview

Communication/Software

Communication between the Power System and the User's CPU is accomplished with a standard USB cable. Once the Power System is recognized by the CPU, a device driver will be installed on the CPU allowing ports to open for communication. The communication driver is included with the GUI software and will normally install automatically. In the event that the device driver does not install correctly, please contact IT for further assistance.

The system communication software includes two user interfaces; the Main User's interface and the Advanced Functions interface. These interfaces are provided on the display on the host computer. The information provided in these interfaces is ported to the host computer via a standard USB connection between the 400 Series Power Monitor and the host computer.

The Main User interface can be resized using the standard window resizing feature.

If this display is terminated by selecting the "x" in the upper right hand corner; the software will continue to run. The software logo icon is displayed in the notification area of the windows toolbar.

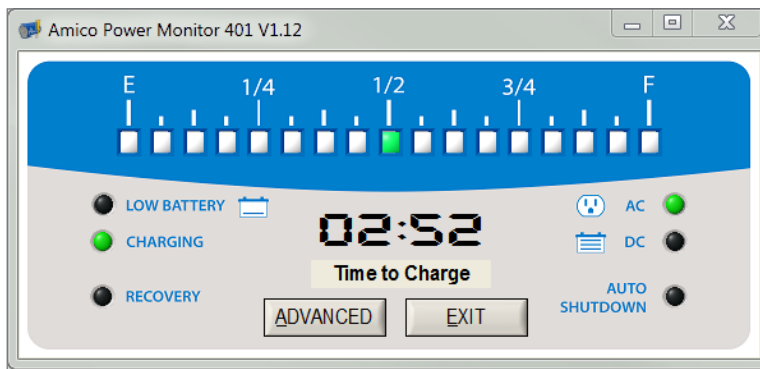

Main User's Interface

The 400 Series communicates with the host computer and provides a graphical interface to the user through the host computer display. Although this communication provides useful and extensive features, it is technically optional as the system will operate without this communication link. It is strongly advised, however, that these features and the link be used to take full advantage of the capabilities of the system.

Section 2: System Overview

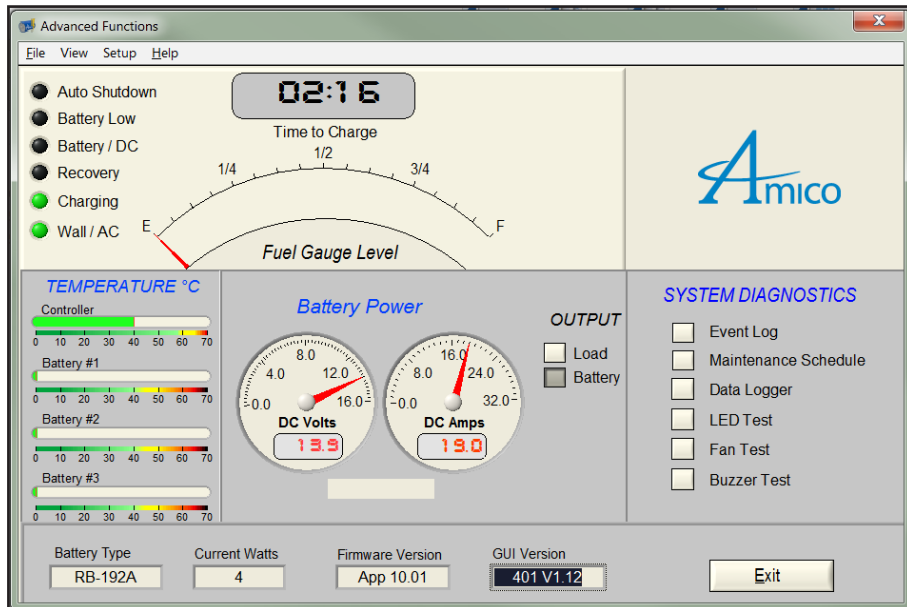

Advanced Functions Interface

The Advanced Functions screen provides a variety of detailed information to be used for evaluation of the power system and the components attached. It also allows for the System Setup of the different types of batteries, the length to scheduled maintenance and other onetime set up parameters.

This Advanced Functions screen is used by the user's IT department or other skilled technician as described in this manual. This advanced functions screen provides further information besides the main user interface. It displays the temperatures of the controller and the batteries, the actual current and voltage draw or charge, display the battery information, the firmware and GUI version, and features to test several controller functions.

The Main User's interface is also available through a remote display mounted directly to the cart. It is constructed to mimic the display as viewed on the host computer's display. It is essentially identical however it does not include the time to charge/discharge information or the AC Module indication of the Series 451 like computer's display.

Section 2: System Overview

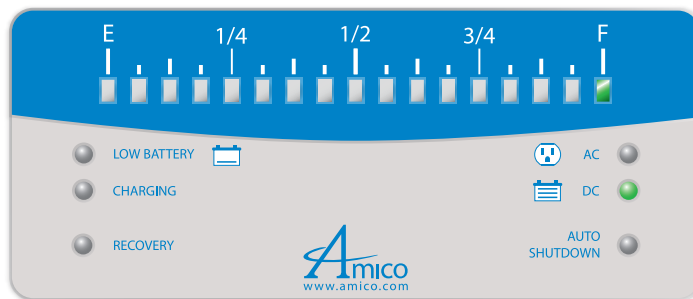

The Main User's interface provides a variety of information to the user [typically the Nurse] relating to

1. The current connection,(Power Source) as AC or DC
2. Indication that the unit is charging the battery
3. Indication that the battery charge is low
4. Indication that the unit is being shut-down due to insufficient battery charge
5. Indication that the unit is recovering a severely discharged battery
6. The current charge status of the battery (SOC)
7. The status of the battery charge to either (1) the time remaining until discharge or (2) the time remaining to Full Charge

To completely exit the software and turn off the 400 Series interface to the CPU, the user must select the "Software Exit" tab beneath the "File" pull down menu on the Advanced Functions display screen. This will turn off the software and remove the icon from the notifications toolbar.

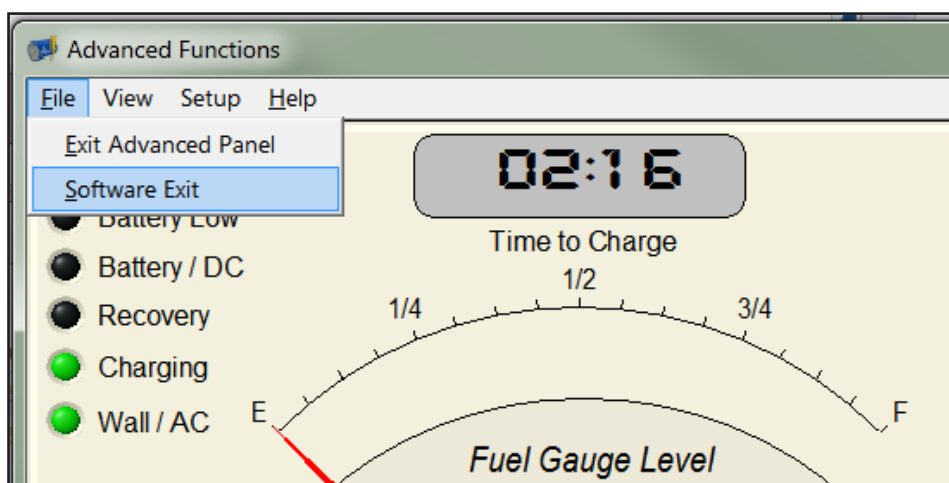

Section 2: System Overview

Intended Use

The Series 400 Power System is intended for use within mobile powered carts or similar applications. The system provides a sustainable and rechargeable source of energy for mobile applications. The system is intended for indoor use within a Hospital or Long Term Healthcare environment. The system is not intended to experience significant vibration or physical shock. The system is intended to be placed within a protective enclosure provided by the cart manufacturer that will, among other things, eliminate its exposure to liquids or materials that may unintentionally be dropped onto the system. It is recommended that the OEM provides ventilation on their enclosure to allow ample airflow and cooling.

Section 3: System Description

Enclosure

The 400 Series Enclosure safely houses the components (Motherboard, Power Supplies and optional AC Module). The enclosure is made out of steel and is earth grounded when connected to a wall outlet or other grounded AC source of power [AC input source interface is provided by the cart manufacturer].

The 400 Series Enclosure includes ventilation for efficient cooling. There are two cooling fans to push ambient air in and slotted vents around the perimeter that allow hot air to vacate. Avoid blocking the ventilation areas and fans. Insufficient air flow can cause overheating and can reduce performance.

The 400 Series Enclosure can be mounted in any orientation. There are 6-32 threaded inserts provided on two surfaces for secure mounting. The user is to provide the mounting screws (refer to installation drawing in this manual for mounting hole locations and maximum screw lengths).

Power Supplies

The two internal power supplies are modular and are mounted to the Motherboard. They provide power for battery charging and driving the loads when AC Power is present. The supplies feature active Power Factor Correction [PFC]; universal input from 100-240 VAC, 50-60 Hz; and are fully approved [independently] to IEC 60601 Medical Safety Requirements.

Motherboard

The Motherboard is the main system element, the primary circuit board, containing the intelligence and the logical connections by which the other components of the system communicate. It is also the location of onboard memory used to store State of Charge (SOC), monitoring of events, thermal sensing, and the operational firmware.

The Motherboard has internal connectors to interface with the power supplies and optional AC Module. The Motherboard also contains multiple connectors for AC Input, DC Outputs, interfaces to the host computer via a Universal Serial Bus (USB), Remote User Interface (Display), temperature sensor(s), I2C BUS, fuse holder, and optional external fan.

AC Module (Series 451 only)

The optional AC Module provides up to 200 W of 115 VAC power in addition to the multiple DC outputs of the Model 401. The AC Module is internally mounted to the Motherboard.

Section 3: System Description

Remote Display

The Remote Display is the remote user interface (RUI) representing the information necessary for normal operation of the power system and cart. The RUI displays, among other items, a gas gauge representation of the charge state of the battery.

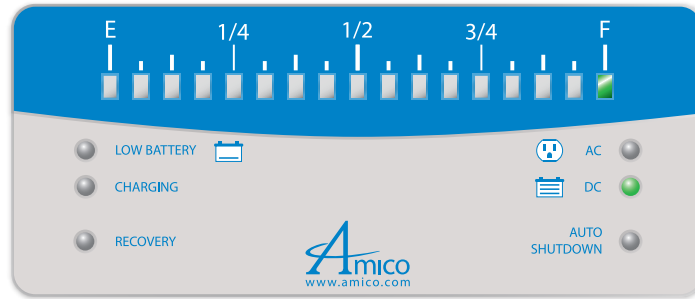

Remote Display

Temperature Sensors

The Controller utilizes digital temperature sensors to maintain safe operation and control cooling. There are multiple internal sensors, and connections for external sensors. The external sensors are used to measure the temperature at the post of each SLA battery. The system will alert the user if a temperature sensor is not installed or is damaged within 5 minutes after the start of a charge cycle if SLA batteries are used. The sensors allow the controller to shut down if it detects an over temperature of the battery. Lithium Iron Phosphate batteries do not require temperature sensors.

Fan Control

The system provides two 80 millimeter (mm) fans that are temperature controlled and variable speed. They operate continuously when the battery is being charged, and operate when the temperature is elevated under all conditions.

A connector is provided for an optional 12 V external fan. This may be used to cool other electronics in the system. The external fan operates in the same manner as the internal fans. External fans must be limited to a maximum of 3 Watts /250 mA.

Fan performance has been selected to provide the most optimal cooling while minimize power consumption and noise.

State of Health

The system continually calculates, in the background of the host CPU, the State of Health (SOH) of the battery(s). This calculation compares a theoretically ideal battery with the current state of the battery. It provides this calculation based on a relatively complex algorithm that compares charge and discharge rates from the battery in the system with an ideal battery.

The SOH parameter provides the user the relative life left in the battery as a percentage. A battery with a SOH indication of 70% would be representing that the battery can sustain 70% of the energy of an ideal battery and therefore will provide roughly 70% of the duration of an ideal battery if all other parameters [load, temperature...Etc] are equivalent.

Section 4: System Connection

Description and Location of Parts

The system connection is through bulkhead connections on the Power System enclosure. The external fan connector is located on the far left followed by the AC Input Power connector, fuse connection, Battery Input, I2C connector (I/O) for battery temperature sensors, the USB connector, Remote Display (RUI) connector (CAT5), and the DC load output connector. For the 451 Model only, the AC Output connector is available above the DC output connector on the right side.

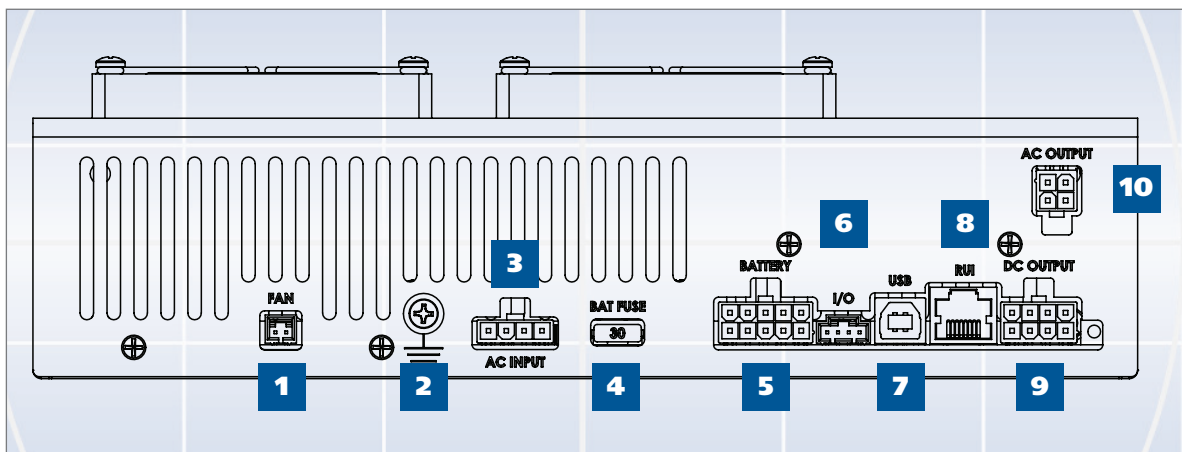

DESCRIPTION AND LOCATION OF PARTS

- | | |
|---|--|
| 1 Auxiliary Fan Port
Thermally controlled, variable speed fan output | 6 I/O Port
Digital communication bus |
| 2 Ground Terminal
For secure grounding to AC power source | 7 USB Port
USB Port for connection to local CPU |
| 3 AC Input
100~240 VAC, 50/60 Hz input | 8 RUI Port
Remote user interface/fuel gauge |
| 4 30 Amp Battery Fuse
User replaceable fuse | 9 DC Output
5 VDC, 12 VDC and 19.5 VDC outputs |
| 5 Battery Connection
Connect single or multiple batteries in parallel | 10 AC Output
120 VAC, 60 Hz, true sine wave output |

Section 4: System Connection

Description and Location of Parts



Series 401/451
(AC Module shown installed)

We recommend, when possible, to connect the battery to the system prior to providing AC power to the system. This allows the system to reset with a battery attached; a more common configuration.

The diagram on the next page represents the basic system connection. The table and paragraphs that follow provide details regarding each connection.

Section 4: System Connection

Diagram of Connections

SERIES 451 MOLEX CONNECTOR PINOUTS

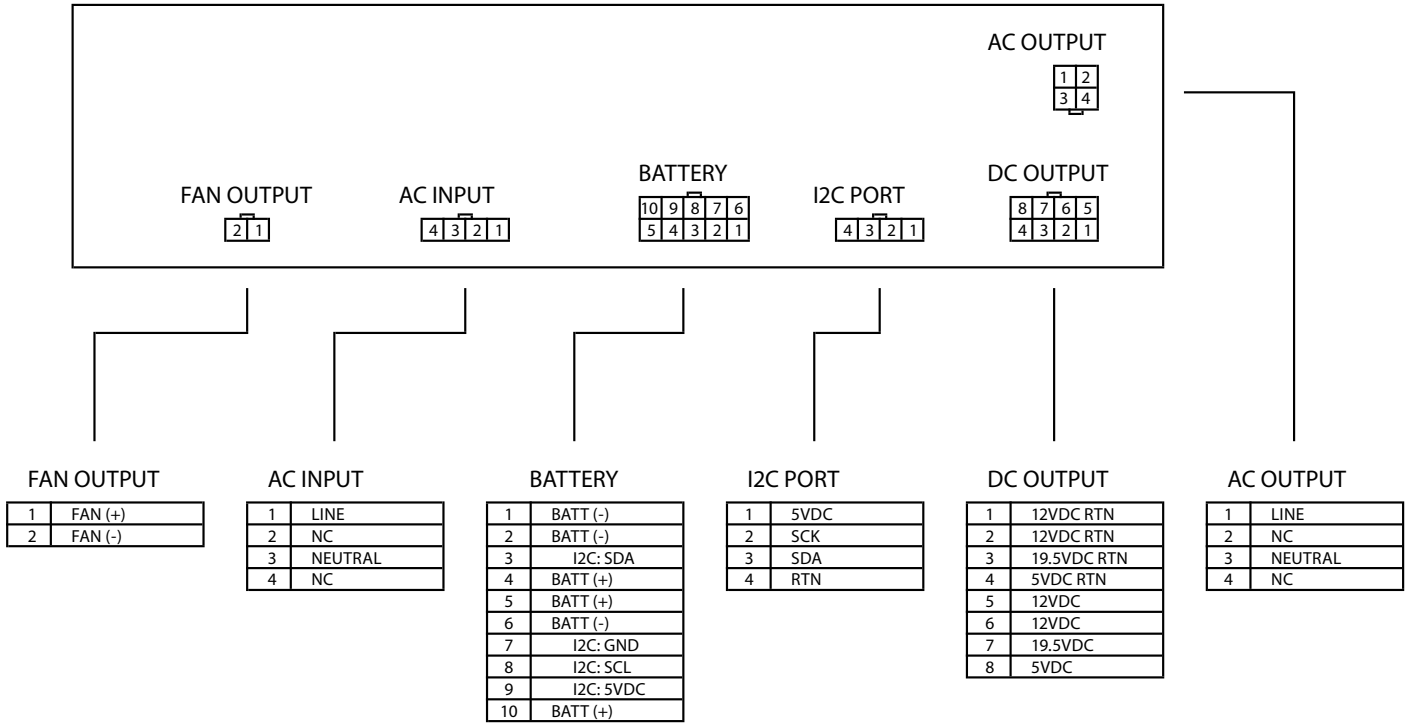

SERIES 451 MATING CONNECTOR PART NUMBERS

ITEM	QTY	REFERENCE	DESCRIPTION	MFG	MFG PN
1	1	AC INPUT CABLE CONNECTOR	RECEPTACLE HOUSING, 4 POSITION, SINGLE ROW	MOLEX	39-01-4040
2	1	BATTERY CABLE CONNECTOR	RECEPTACLE HOUSING, 10 POSITION, DUAL ROW	MOLEX	39-01-2100
3	1	DC OUTPUT CABLE CONNECTOR	RECEPTACLE HOUSING, 8 POSITION, DUAL ROW	MOLEX	39-01-2080
4	1	AC OUTPUT CABLE CONNECTOR	RECEPTACLE HOUSING, 4 POSITION, DUAL ROW	MOLEX	39-01-2040
5	14	CRIMP FOR BATTERY AND DC OUTPUT CABLES	FEMALE TERMINAL, TYPE 45750, FOR 16 AWG WIRE	MOLEX	457503111
6	4	CRIMP FOR AC INPUT AND AC OUTPUT CABLES	FEMALE TERMINAL, TYPE 45750, FOR 18 AWG WIRE	MOLEX	457501111
7	2	RING TERMINAL FOR AC INPUT AND AC OUTPUT CABLES	RING TERMINAL, INSULATED, FOR 18 AWG WIRE	AMP	54774-2
8	1	TEMP SENSOR/ACCESSORY CABLE CONNECTOR	CONNECTOR HOUSING, 4 POSITION, SINGLE ROW	MOLEX	50-57-9404
9	1	FAN CABLE CONNECTOR	CONNECTOR HOUSING, 2 POSITION, SINGLE ROW	MOLEX	50-57-9402
10	6	CRIMP FOR TEMP SENSOR/FAN/ACCESSORY CABLES	FEMALE TERMINAL, TYPE 71851, FOR 22-24 AWG WIRE	MOLEX	16-02-0102

SYSTEM I/O

Section 4: System Connection

AC Power Input

AC Input Power is applied to the system through a 4-position Molex Connector. A #6-32 threaded hole is provided for chassis ground termination. AC Power is assumed to be consistent with standard wall power [European or U.S.]. The screw should not be longer than five sixteenths of an inch (5/16") long and not powder coated.

The AC Input Voltage earth ground complies with bonding impedance requirements when it is attached to a standard AC wall outlet. There is no required or provided earth ground bonding when the end-use system is mobile.

The 400 Series Controller does not require external EMI Filtering to meet UL 60601 standards. However at the system level, it may be beneficial to use an AC Line filter at the entrance to the system enclosure when there are other active electronic devices within the enclosure. The suggested part is Corcom 10EBH1 or equivalent.

Batteries

Batteries are connected to the power system through a 10-position Molex Connector. Multiple battery installations must be connected in a "parallel" configuration thereby providing 12 volts to the system.

Refer to the system I/O diagram for connector pin out. Each pin is rated for 10 Amps maximum and 16 AWG wire is recommended. It is required that all three conductors be used in the battery harness for charging current higher than 15 Amps. Maximum battery charge current for the system is 25 Amps shared over all three conductors. Although smaller batteries may not need all three conductors, it is still recommended all be used for best performance. It is also recommended that the configuration minimize wire length and other added resistive effects. It is further recommended that the resistive effects of wire length or other elements are balanced between batteries.

The wire harnesses to the battery must be tightly secured to the battery terminals using the torque recommended by the battery manufacturer. Caution: Insufficiently secured DC power connections may result in compromised safety of the battery, the wiring, the controller, and the system. Required battery fuse replacement is the mini-blade fuse 32 V, 30 A by Littelfuse part number 0297030.WXNV.

Several recommended battery connections are described in the diagrams below. Please note wire gauge and connection should be in accordance with UL ratings and specifications:

Battery Connection Diagrams

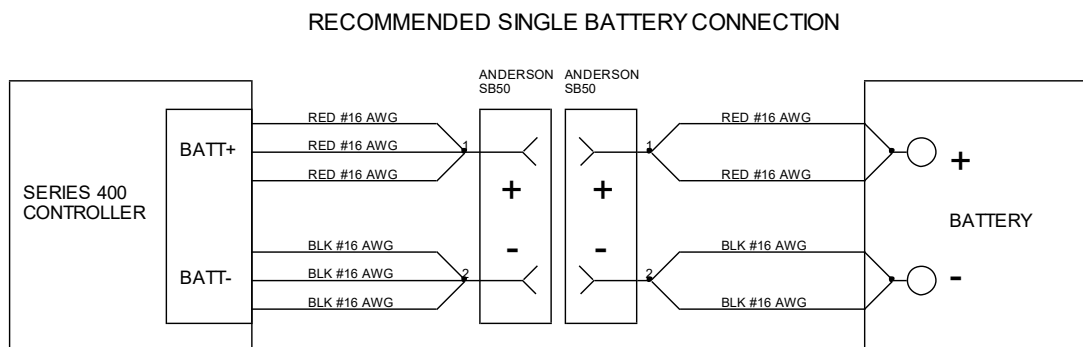

Section 4: System Connection

Battery Connection Diagrams

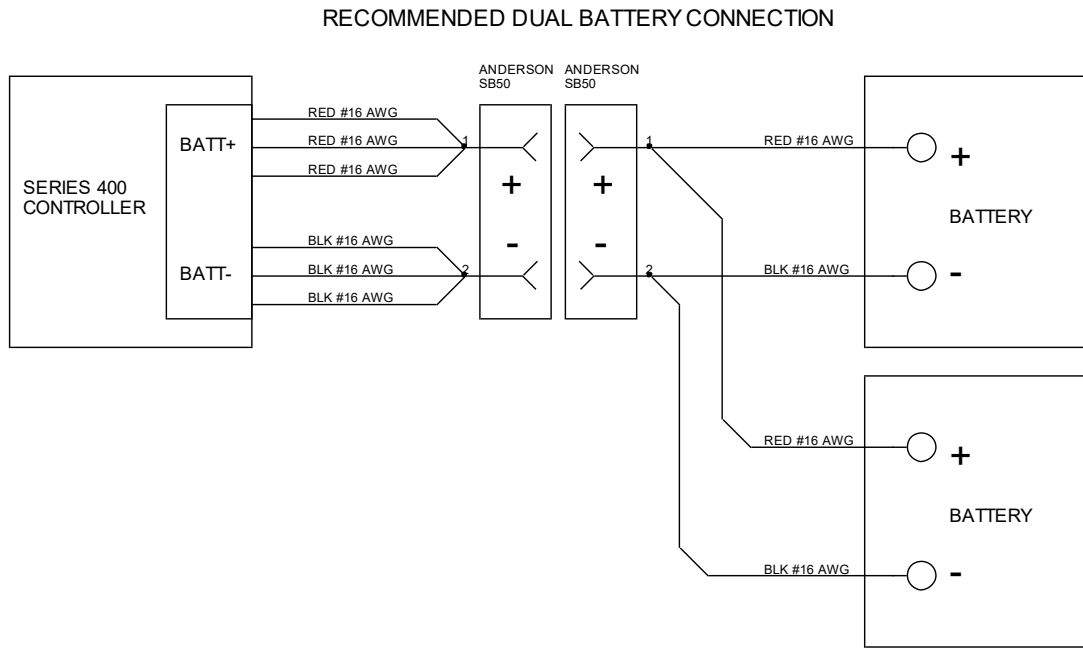

Temperature Sensors

The system configuration, one or two SLA batteries, will determine if one or two temperature sensors are necessary. Lithium Iron Phosphate batteries do not require temperature sensors. The temperature sensors are connected to the negative post of each battery, as shown in the figure below.

i NOTE: For single battery connections, the “Bat 1” temperature sensor must be used; for dual battery connections, a “Bat 1” and a “Bat 2” temperature sensor must be used. The sensors are addressed uniquely thereby providing access to each battery temperature independently. Failure to install Bat temperature sensors if an SLA battery chemistry is selected will cause the system to Shut Down after 5 minutes.

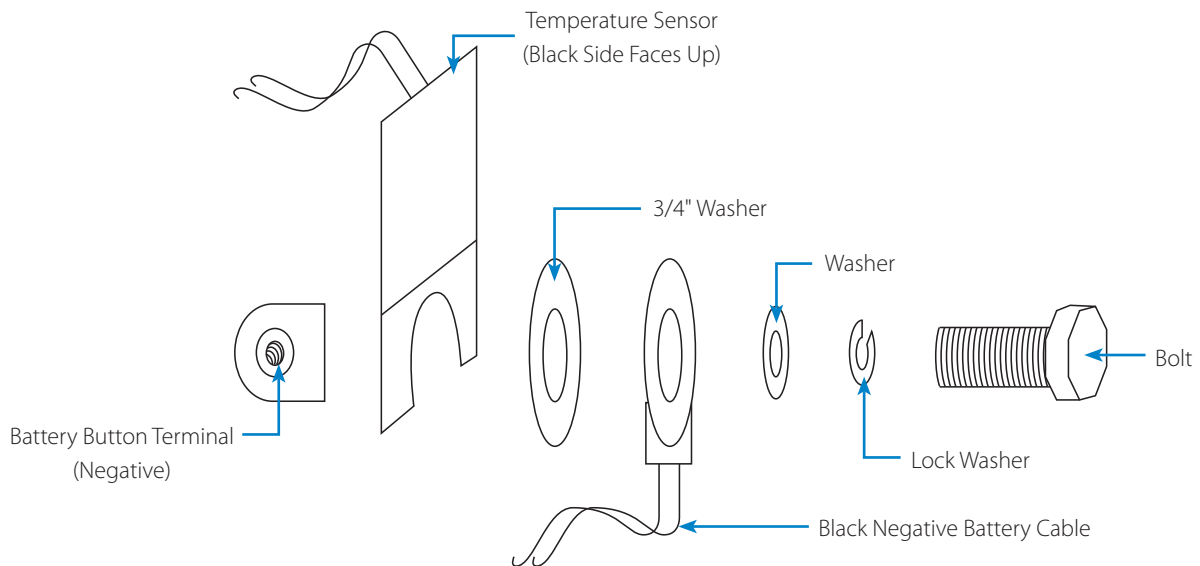

Button Terminal Temperature Sensor Mount Figure

Section 4: System Connection

The battery temperature sensors are controlled using an I2C bus. Each item is specifically addressed therefore the connection to each can be through any I2C connector. In the above diagram, therefore, any I2C connection can be interchanged with any other without any functional effect.

Host Computer

The host computer connects to the Power System through a standard USB connection. When connecting the system to the host computer it may take up to 30 seconds for Windows to recognize the device, allow drivers to install, and then begin communication. If this does not occur, please contact the manufacturer.

It is recommended to run the GUI software on the host PC to take advantage of the battery management features. In addition, using any available power saving features on the PC and Monitor may improve battery run times significantly.

Small PCs and All-in-one PCs

Small PCs and All-in-One PCs are compatible with the 400 Series Controller. Small PCs and All-in-One PCs provide the best economic space and best power consumption.

Laptop

If the host computer is a laptop and its associated internal laptop battery is left installed, the 400 Series may not operate correctly. The time estimations for charging and discharging will be effected by the requirement to charge and discharge the laptop battery.

While calling for charge current to charge the laptop battery, the 400 Series System will over-estimate the current necessary to support the loads (which include the battery) attached to the system and will not factor in the reduced current needed after the laptop battery reaches full charge. This will result in a significant error during the discharge cycle as the laptop battery requires intermittent recharging from the 400 Series System batteries.

If the laptop battery is in place, the 400 Series System will estimate the time remaining to discharge accurately. However during charge the presence of the laptop battery will affect the 400 Series System ability to predict charge time due to the unanticipated draw from the laptop battery.

It is strongly recommended that the user remove the laptop's battery prior to use with the 400 Series System. The time available to the PC is unchanged since the 400 Series System battery depletion will be similar regardless of the laptop battery's presence; the system will require the 400 Series System batteries to be recharged regardless of the state of the laptop battery.

The 400 Series System will gracefully turn off the laptop without the presence of the laptop battery when the batteries are nearing full depletion. The laptop battery is not necessary for added protection of the user's data.

Remote Display

The remote display (RUI) uses a standard Category 5 connection (CAT5) to the system; straight through type; not patch type. This is used for the convenience of a standard cable; the system is not compatible for use within a networked system.

DC/AC Output Power

For Models 401 and 451, DC Output Power is provided through an 8 position Molex connector. Refer to the System I/O diagram above. There are two 12 VDC outputs and returns; both must be used to split the load if current will exceed 10 Amps. There is also a 19.5 VDC output and a low power 5 VDC/ 2 A output. The combined total power for all three outputs is 200 watts. Outputs may be used simultaneously as long the total power is not exceeded.

Section 4: System Connection

For the Model 451 only, AC Power is provided through a 4-position Molex connector. A #6-32 threaded hole is provided for chassis ground termination. Refer to the System I/O diagram above. The screw should not be longer than five sixteenths of an inch (5/16") and not powder coated. A ferrite component (Fair-rite part number 0431164281) is required on the AC output cable located approximately 2 inches from the Molex connector for EMI compliance. As with the Model 401, all DC outputs can be utilized along with the AC output as long as the combined output power (both AC and DC) does not exceed 200 Watts.

Thermal Sensors

The thermal sensor connections are addressed through an I2C bus protocol and will operate appropriately when connected to the bus.

The Thermal sensors are marked "Bat 1" for Battery 1 and "Bat 2" for Battery 2, in concert with their appropriate permanent addresses as manufactured, if more than one sensor is necessary. These channels will correspond with the designations on the Advanced Function Screen references. The User should note which of the batteries is designated as 1 and which is designated as 2 prior to final OEM system assembly. DO NOT use two battery sensors of the same address in the same system. This will cause bus address conflicts and will not provide reliable data.

The I2C connector type that is used is meant for few connect/disconnect cycles and should not be abused through repeated connections.

The second thermal sensor connection is located in the center of the battery connector. Refer to the System I/O diagram above. For the correct mounting instructions of the thermal sensors, refer to section 4.2.

Section 5: Installation of Software

Host PC Software

The licensed Host software (Graphics User Interface –GUI) will be provided by Amico Accessories Inc. for customer use. The PC software is easy to install from the provided software package. The installation file will prompt the user through typical Windows setup instructions.

It is critical that the appropriate driver is loaded for the product. If the driver is not loaded appropriately the software will not function. The driver is part of the software provided and can be found in the programs folder. Typically, the location is C:\Program Files (x86)\AM Series 401.

If for any reason the software is required to be reloaded, it is strongly advised that all software is fully removed from the system, inclusive of drivers, and all components are reloaded.

If you do not have or did not receive the software package, please contact Amico Accessories Inc. or an authorized representative.

Section 6: Initial Testing and Error Conditions

Remote Display

The Advanced Functions screen provides a convenient LED Test. This test will cycle through all of the LEDs on the Remote display providing an easily recognizable sequence of on/off for each. A failed LED will not light. If the LEDs are not sequencing, then the processor or a connection has failed.

Battery

If AC power is not connected and the battery is appropriately connected and has charge, then the Pop Up on the host computer [Main User's Interface Screen] will provide a time to discharge. The time to discharge calculation may take up to 5 minutes to display due to the delay in the power system evaluating data and preparing a state of charge [SOC] approximation. Also, the LED indicator on both the Remote display and the Pop Up will indicate DC Power. Prior to evaluation, the time to discharge may display solid "-"marks with a flashing on/off colon. The flashing on/off colon indicates that the system is operational and communicating.

The LOW BATTERY indicator will activate if the battery power is below a prescribed limit.

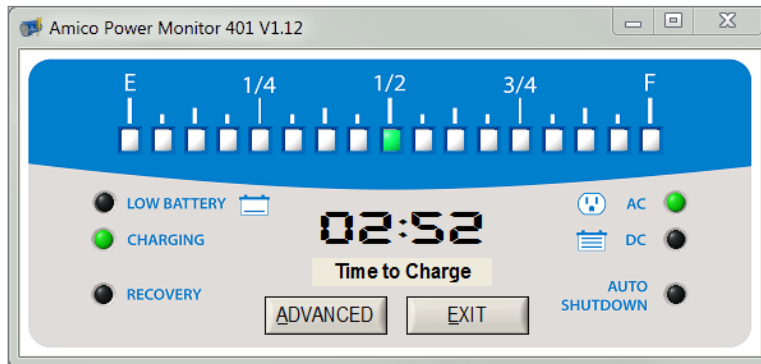

Main User's Interface

Main User's Interface

If the batteries are not connected and the AC power is connected to the wall outlet, the display will show AC power and Recovery. The system is trying to recover since the disconnected batteries indicate, since they are not connected, a very low voltage battery condition. After a time threshold is reached without battery voltage increasing, the charging system stops trying to recover the batteries and indicates a Charger Time Out or Bad Battery condition. This error will be provided to the event log.

AC Power

When the system is plugged into a working standard AC Outlet [the end use system provides the interface to wall power], the AC indicator and the CHARGING indicator will be active on both the Remote display and the Pop Up. The CHARGING indicator will flash while charging and will turn off if the battery is fully charged.

The time to charge estimation may take more than five (5) minutes to calculate and stabilize.

System Communication with the Host

The system communication is operational if the host Pop Up displays valid information from the system. If the communication is not operational, a USB error message will be displayed, or, the Pop Up will display static information.

Section 6: Initial Testing and Error Conditions

Sleep Mode

Sleep Mode is a very low power state used for long-term storage, shipping, and protection against over-discharging a battery. In this state the Remote display LEDs and USB port do not operate.

The System will enter Sleep Mode under the following conditions:

1. The battery is connected to an unpowered system – this allows a system to be stored or shipped while the battery is connected without discharging the battery.
2. The battery charge level is very low – sleep mode is automatically entered to prevent further discharge of the battery.
3. Software command from the Advanced Functions Screen. This command may be used to preserve battery charge if the system will be stored without AC power for an extended period. The Activate Sleep Mode function provides a 10 minute window for the user to save all work. The Sleep Mode function initiates an immediate command to place the unit into sleep mode.

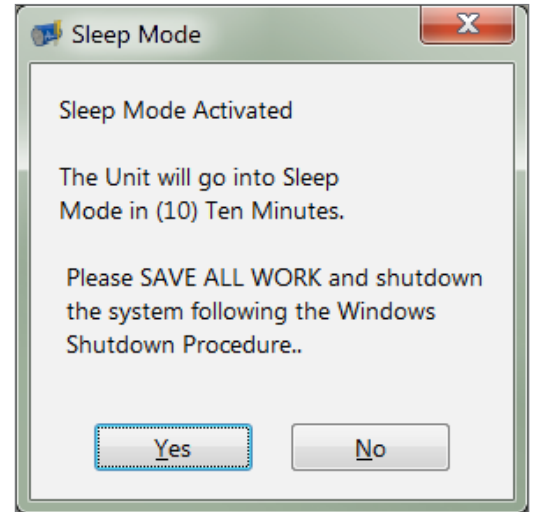

The system will wake up from Sleep Mode when AC power is applied. Remote display and USB operation are restored. The system will remain awake as long as a battery with sufficient charge level is connected.

Error Conditions

The 400 Series has three error conditions. The event log will record each error condition if it occurs. The error conditions are Over Temperature, Over Load and Charger Time Out. The Remote Display will simultaneously flash both the Recovery LED and either the DC or AC LED depending on whether the system is running off of battery or AC power.

Over Temperature

If any of the temperature sensors identify a temperature above a prescribed threshold, the system isolates the battery[s], no more current flows in or out, until the system is plugged into an available AC wall outlet. If it is already plugged into a wall outlet, it must be unplugged and re-plugged to clear the error condition.

The remote display shows the error condition as follows:

On AC power: "Recovery" and "AC" blink simultaneously

On battery power: "Recovery" and "DC" blink simultaneously

The User should check the condition of the temperature sensor on the battery and confirm the temperature sensor was correctly installed. If the temperature sensor was damaged or incorrectly installed, an Over Temperature warning may occur.

Section 6: Initial Testing and Error Conditions

Overload

If the system senses a power draw in excess of 250 Watts for the load devices, the system isolates the output until the overload condition is removed and the error condition is cleared by plugging into an available AC wall outlet. If it is already plugged into a wall outlet, it must be unplugged and re-plugged to clear the error condition.

The remote display shows the error condition as follows:

On AC power: "Recovery" and "AC" blink simultaneously

On battery power: "Recovery" and "DC" blink simultaneously

The User should check the wire of the device or the device that is connected to the system. A damaged device and or a pinched wire can cause an Overload to the system.

Charger Time Out or Bad Battery

If the system senses that the charge time has exceeded reasonable limits, the system isolates the battery[s], no more current flows in or out, until the system is plugged into an available AC wall outlet. If it is already plugged into a wall outlet, it must be unplugged and re plugged to clear the error condition.

The remote display shows the error condition as follows:

On AC power: "Recovery" and "AC" blink simultaneously

On battery power: "Recovery" and "DC" blink simultaneously

System Reset

It would be highly unusual for the system to require a reset. There is a very unique set of circumstances that could affect the performance of the system.

If the system were to "hang up" and the Remote Display was inconsistent with the pop up Main User Screen on the CPU, it would indicate that the User Interface was no longer performing correctly. If the system were to display that the USB connection has failed, simply wait a few seconds for it to recover. If it does not recover, cycle the USB connection on the CPU. If this does not recover the communication [after waiting for 10 or more seconds], then cycle the USB connection to another USB port on the CPU. If these events do not recover the communications, then resort to the steps listed below.

- Plug the unit into the wall; assess if the unit has recovered.
- Unplug the unit from the wall; assess if the unit has recovered.
- If possible, select the "Exit Software" choice from the "File" pull down menu on the Advanced Functions screen. Cycle the USB connection to the CPU. Restart the software; assess if the unit has recovered.
- Cycle the USB connection to an alternate USB port on the CPU; assess if the unit has recovered.
- Restart the computer.
- Unplug the unit from the AC source and from the Battery and wait 30 seconds. Reconnect to the Battery and then to AC power; assess if the unit has recovered.

If the Remote Display is not lit, regardless of the state of the CPU interface display, this may indicate the controller is at fault. If it is not the connection between the Remote Display and the controller [cycle each connection to check] then the product should be returned for investigation.

Section 7: Operation

Turn On

After the initial assembly, connection of the system and the installation of the user software the user must power on the unit and open the Advanced Function Screen to provide the initial setup parameters for use.

The unit may be in "Sleep Mode" for shipping and storage purposes, or if the battery is disconnected or at a very low charge level [reference the "Sleep Mode" section for explanation]. To Power On the system and bring it out of sleep mode, it must be initially connected to an AC Outlet. Once the Remote display LEDs are illuminated and the battery has sufficient charge, AC power may be removed and the unit will maintain operation.

To open the Advanced Function Screen, the user must select the "ADVANCED" button on the Main User's Screen.

The system will ask for a password to allow access to the Advanced Function Screen. The password will be set by the manufacturer and disclosed to the appropriate personnel.

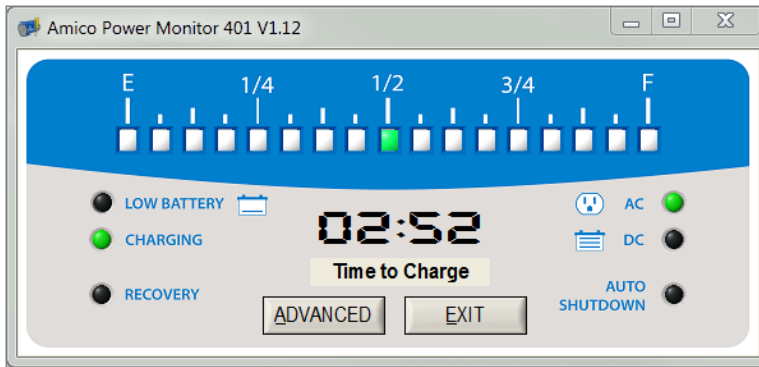

Main User's Interface

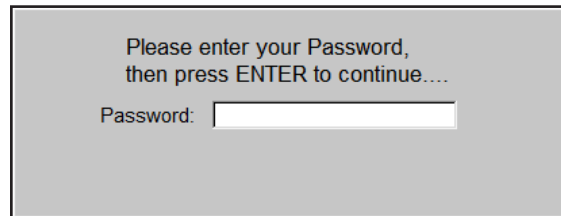

Password Entry Screen

Sleep Mode

Sleep Mode is a very low power state used for long-term storage, shipping, and protection against over-discharging a battery. In this state the Remote display LEDs and USB port do not operate.

This provides the user the ability to put the 400 Series into Sleep Mode through the use of software control. If activated, the user has 10 minutes to shut down the system prior to the system entering sleep mode.

Section 7: Operation

System Set Up

The Advanced Function Screen has a “401 Series Setup” panel found under “Setup” in the main menu bar. This must be selected to enter the initial system parameters.

The Setup parameters are stored in the 400 Series. If the CPU is changed, the Setup parameters remain with the 400 Series system not the CPU. The email parameters are the only exceptions. The email parameters remain with the CPU.

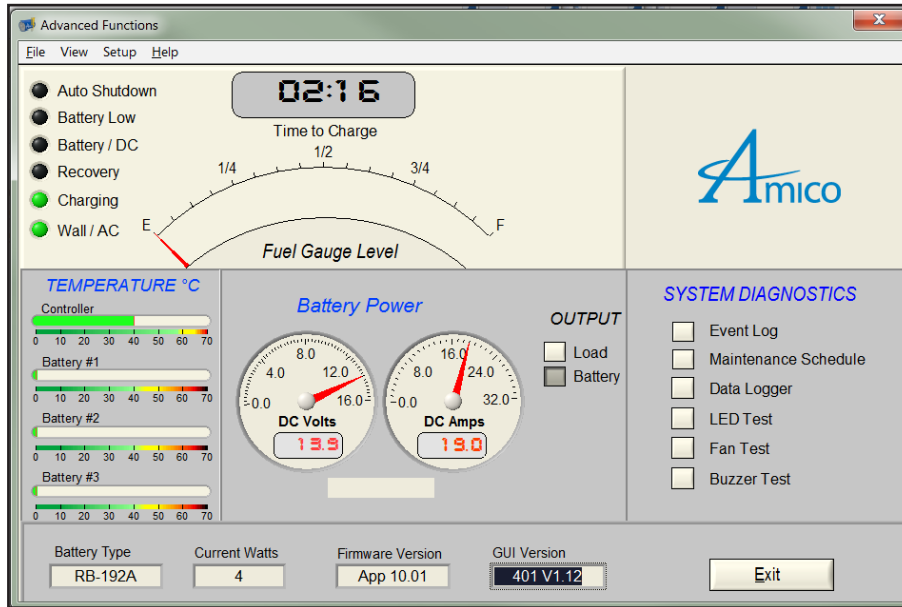

Advanced Functions Interface

The user will then have several setup options available through the pull down selection. The user must provide various configuration parameters and system settings defining the configuration and settings for the specific application. The following paragraphs will address each of the relevant screens and the associated parameter settings.

Section 7: Operation



401 Series Setup Screen

401 Series Setup

The System Setup screen allows the user to enter data containing the identity of the system components. This data includes: types of battery, service date, model type, cart ID, maintenance cycle and duration. The following is a brief description of each field.

- Set Battery; this field is used to select the proper battery type that is installed. A pull down menu provides the supported battery sizes.
- Battery Install Date: This field is updated when the user completes the required information and activates the "SET & SEND" button.
- Model Type: This field displays the battery Model Type. By selecting the Battery to be used, this field will automatically be filled in with the Model Type or part number of the Battery.
- Cart ID: This field is used to identify the CPU. The GUI will automatically extract the CPU identification from the host CPU.
- Maintenance Cycle: This menu allows the user to select the maintenance cycle. There are two cycle types available. This selects the method of alerting the supporting technician to the need for scheduled maintenance.
 - a. Number of weeks; counts the number of weeks from initialization
 - b. Amp Hours: counts the total number of amp hours expended after initialization
- The value represented in the "DURATION" text box represents the threshold value of the chosen maintenance cycle. Only integer values are acceptable. Upon reaching the set threshold, an alert is automatically generated.
- Set & Send: This icon button is used to send the information to the device and to save it to a file to be read when using the maintenance screen.
- Exit: This icon is used to close this screen and return to the diagnostic screen.

Section 7: Operation

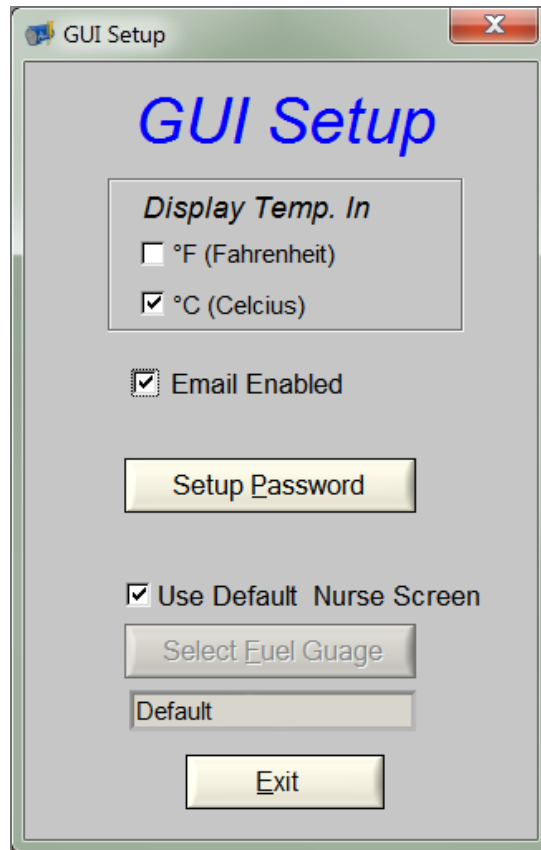

GUI Setup

The GUI Setup screen allows the user to

- Change the temperature display parameter between Fahrenheit and Celsius.
- Activate the Email functionality of the system (this should be checked for email to be enabled).
- Change the default Diagnostic Screen Access password to a user defined password.

Section 7: Operation

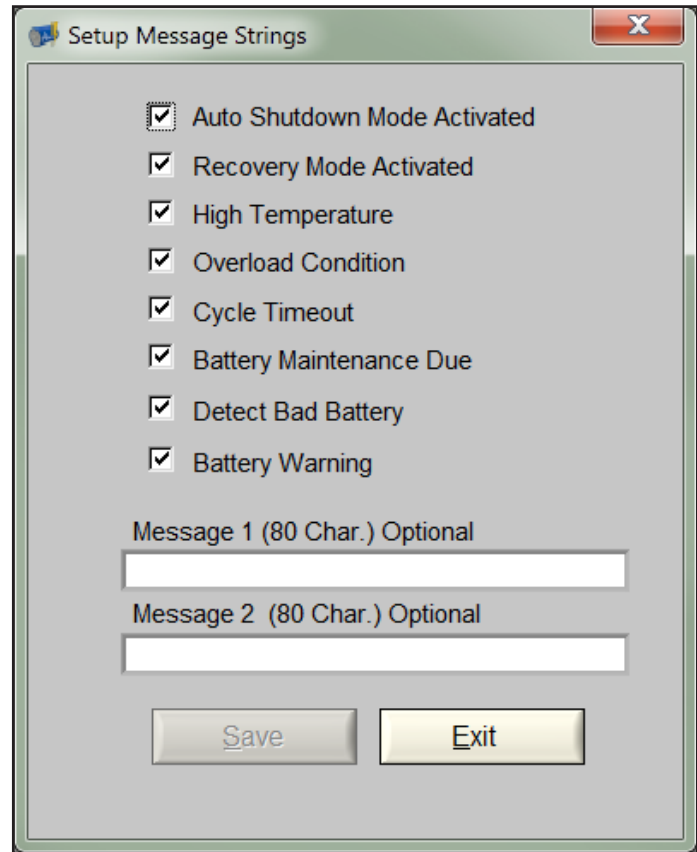

Email Setup

- The IP Address is the SMTP address of the mail server of the network which this device is within. If the mail is leaving the premises, the IP address will be the external location's SMTP address.
- The Recipients Email is the address of the location that the email alerts will be sent to; multiple email addresses may be used.
- The Senders Email is the address assigned by the network administrator that represents the Cart/Power System creating the email.
- The Subject is a user defined field that will be in the "Subject" field of the email.
- The Message Options button icon opens the following screen.

The various selections within the Setup Message screen represent events that, if achieved, trigger an email alert. The email will be structured as described earlier. The message sections are user definable optional fields.

Section 7: Operation

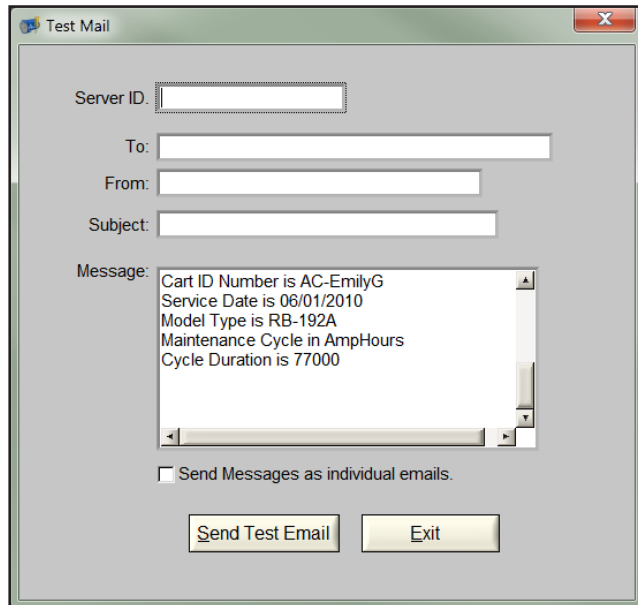

Test Email

This function provides a testing capability for the user to evaluate the information that has been provided in setting up the email.

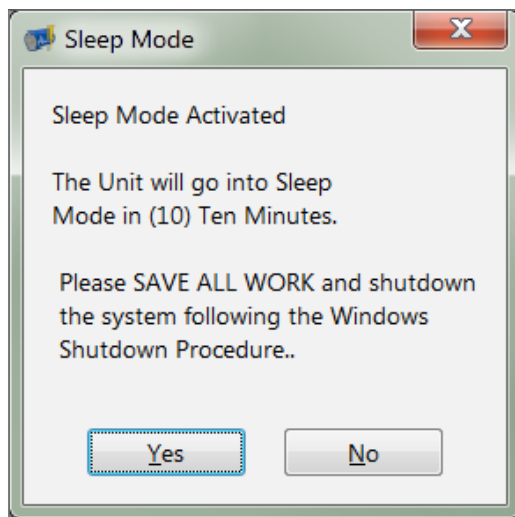

Sleep Mode Activation

This provides the user the ability to put the 400 Series into Sleep Mode through the use of software control. If activated, the user has 10 minutes to shutdown the system prior to the system entering sleep mode.

Buzzer

This allows the user to turn the Buzzer on or off. If the buzzer is selected as "disabled", the buzzer will not work under any circumstance. If "enabled", the buzzer will be active if the prescribed parameters are met indicating action must be taken to either (1) charge the battery by plugging into AC wall power or (2) or shut the system down to avoid the risk of lost data.

Section 7: Operation

Upload EEPROM Data

This setup function is provided for the user of the 400 Series to upload new EEPROM data, event log data, from the system to the host PC. The data is located in a file within the AM 401 folder. This provides for an upload of ALL of the available event log data. The Event Log feature displays only the most recent events on the screen.

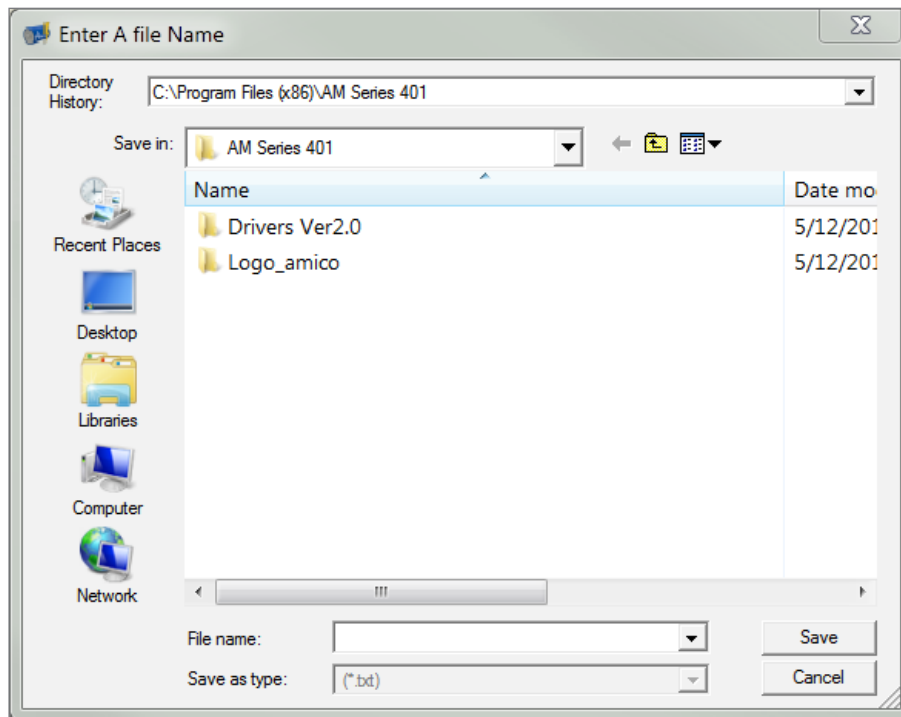

CartTrac (Optional)

CartTrac is an optional software module for cart fleet management.

This function allows the user to setup CartTrac and turn on/off communication to the CartTrac Server. The CartTrac function is password protected and the password is "C@rtTr@c". Once the password has been entered the user can turn on CartTrac and enter the site URL (i.e. http://) address. The user will be able to test the communication to the Server prior to data being transmitted. The field box titled "Unit Location" allows the user to specify the cart location (user editable). The time interval selections pull down allows the user to choose the frequency the data will be sent. After the information has been entered select apply and the communication will begin with the CartTrac server. For more information about CartTrac, refer to the CartTrac manual.

Section 7: Operation

Charging

Subsequent to initializing the system, the 400 Series will either be placed in the charging or discharging state. In the charging state, the AC power connection is plugged into the available wall AC outlet. During this state, the user has access to both the Remote display and the Main User's Screen Pop Up; both of which are displaying key performance data.

NOTE: It is recommended that upon initialization, a full charge is applied to the battery prior to the initial use of the cart.

NOTE: It is recommended that the battery is stored in full, or close to full state for optimum longevity of the battery.

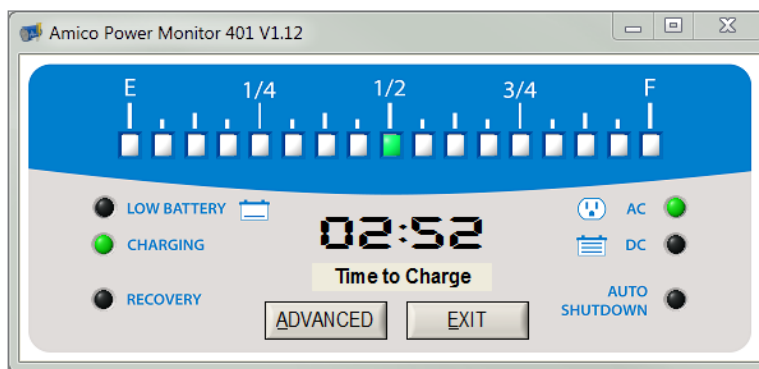

Main User's Interface

- The Gauge; Provides the current charge of the battery. As the battery charges, the illuminated LED indicates the level of charge in the battery.
- Time Remaining; Provides an estimate of the time remaining before the battery has completed the charge cycle. This is an estimate based on a variety of parameters including the state of charge of the battery. This indicator is available on the Pop Up Screen only.
- AC; LED indicates that the system power is coming from the AC- wall outlet.
- Charging; LED displays if the battery is in the charging state. The LED blinks while charging and is off if the battery is fully charged.
- Auto Shutdown; LED represents that the battery has entered into an auto shutdown mode due to low battery power. This LED will not become active while charging.
- Recovery; LED is used to indicate that the battery has entered an over discharged condition. This happens when the battery power is detected to be below a predetermined level of charge. The Deep Discharge Reconditioning is an algorithm to charge batteries in a "RECOVERY" mode; a very controlled slow charge that charges the battery without creating a run away or high temperature condition. This unique process provides the best chance to recover a battery that has been over discharged. This process may take 24 hours or more.

There are two buttons on the Main User's Screen Pop Up; these buttons are:

- Advanced; Allows the user to enter into the Advanced Function screen. After selecting this icon, the user is prompted to enter a password. The Main User is not expected to be allowed access to the Advanced Function screen. The intent of the Advanced Function Screen is to provide a tool for a trained technician.

Section 7: Operation

- **Exit;** Icon is used to exit the program. This does not turn the program off it simply eliminates the Main User's interface screen. The program continues to run in the background and provides an icon in the notification tool bar that can be activated to turn the Main User screen back on again.

If charging with a laptop battery in place, the load current may change significantly based on the charge algorithm required by the laptop. This may affect the algorithms used to predict charge time remaining. After the laptop battery reaches a full charge, the 400 Series will predict the charge time remaining more accurately and with more stability. We recommend, if using a laptop with the 400 Series, that the laptop is used without its internal laptop battery installed.

Discharging

The Discharging state is an alternative state that the system can be in after initialization. The Discharging state is when AC Power is unplugged from the wall outlet. The battery will be discharging as it is used by the components available on the cart consuming the available battery energy.

- **The Gauge:** Provides the current charge status of the battery. As the battery charges, the illuminated LED indicates the level of charge in the battery.
- **Time Remaining:** Provides an estimate of the time remaining before the battery is completely discharged. This is an estimate based on a variety of parameters including the state of charge of the battery. This indicator is available on the Pop Up Screen only.
- **Low Battery:** LED is displayed if the battery charge is reduced to a preset threshold determining low battery level. If the Gauge indicates one of the lower 3 level indicators, then the battery is low.
- **DC:** LED indicates that the system power is coming from the batteries.
- **AC:** LED indicates that the system power is coming from the AC- wall outlet. This will not be active in the discharge mode.
- **Charging:** LED is displayed if the battery is in the charging state. The LED blinks while charging and is off if the battery is fully charged. This will not be active in the discharge mode.
- **Auto Shutdown:** LED represents that the battery has entered into an auto shutdown mode due to low battery power.

If the low battery threshold is reached, the following dialog box will appear to prompt the user to plug in the power system to charge the battery. If this is not done, the Auto Shutdown sequence begins.

A dialog box appears warning the user when there are 10 minutes remaining before the system will perform and orderly shutdown. Five minutes prior to shutdown, the Auto Shutdown LED begins to flash and a second dialog box will appear warning the user.

There will also be audible alert from the power system that will sound every 10 seconds until the system shuts down if the buzzer has not been disabled. If the user fails to turn the system off, the system will perform an orderly shutdown and the Shut Down in Progress dialog box will appear.

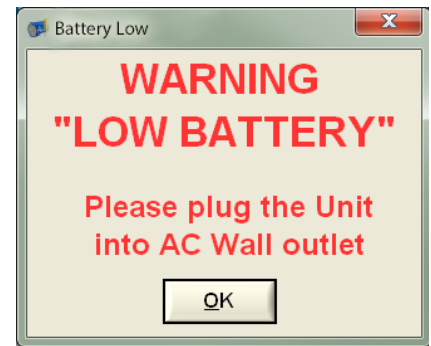

Low Battery Prompt

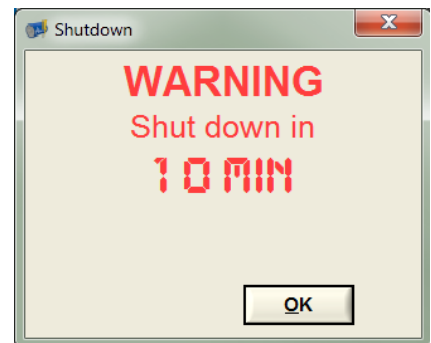

Shutdown Warning

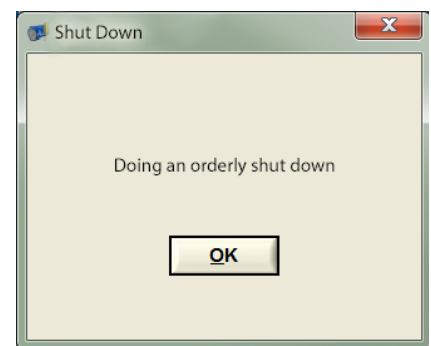

Shut Down in Progress

Section 7: Operation

- Recovery; LED is used to indicate that the battery has entered an over discharged condition. This happens when the battery power is detected to be below a predetermined level of charge. The Deep Discharge Reconditioning is an algorithm to charge batteries in a "RECOVERY" mode; a very controlled slow charge that charges the battery without creating a run away or high temperature condition. This unique process provides the best chance to recover a battery that has been over discharged. This process may take 24 hours or more.

There are two buttons on the Main User's Screen Pop Up; these buttons are:

- Advanced; Allows the user to enter into the Advanced Function screen. After selecting this icon, the user is prompted to enter a password. The Main User is not expected to be allowed access to the Advanced Function screen. The intent of the Advanced Function Screen is to provide a tool for a trained technician.
- Exit; Icon is used to exit the program. This does not turn the program off, it simply eliminates the Main User's interface screen. The program continues to run and provides an icon in the notification tool bar that can be activated to turn the Main User screen back on again.

If a laptop with an internal battery is used with the 400 Series power system during discharge, the laptops battery may request higher or lower current than the laptop is using to either charge its internal battery or to run from its internal battery. This configuration will operate but the algorithms in the 400 Series will not work effectively in regard to time remaining estimations. We recommend, if using a laptop with the 400 Series, that the laptop is used without its internal laptop battery installed.

Section 8: Field Diagnostics

System Status at a Glance

State of Charge
User friendly Fuel Gauge provides true State of Charge based on battery manufacturer's charge/discharge profiles and the software's algorithms with multiple temperature compensation inputs.

Low Battery Indicator
Amber light indicates that the battery has been discharged to less than 10% battery capacity.

Charge Status
Blinking green light indicates that battery is charging. Steady green light indicates that battery is fully charged and is in Float Mode.

Recovery
Amber light indicates that the battery was over discharged and that the system has entered into an auto-recovery mode to safely recondition and charge the battery.

Power Source
Green light indicates whether source of power is from AC wall outlet or from DC battery.

Auto Shutdown
Steady amber light indicates that the system will perform an orderly Windows shutdown within 10 minutes.
Blinking amber light indicates that the computer will shut down within 5 minutes.

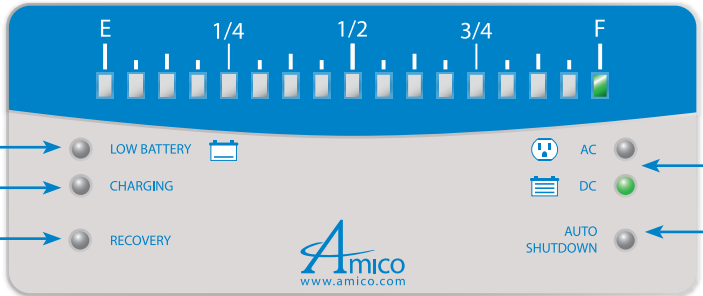

The 400 Series provides access to an interface screen that provides information concerning:

- Current Operational Parameters
- Event Log
- Battery Maintenance Schedule
- Data Logger
- Remote Display LED Test
- Fan Test
- Buzzer Test

Section 8: Field Diagnostics

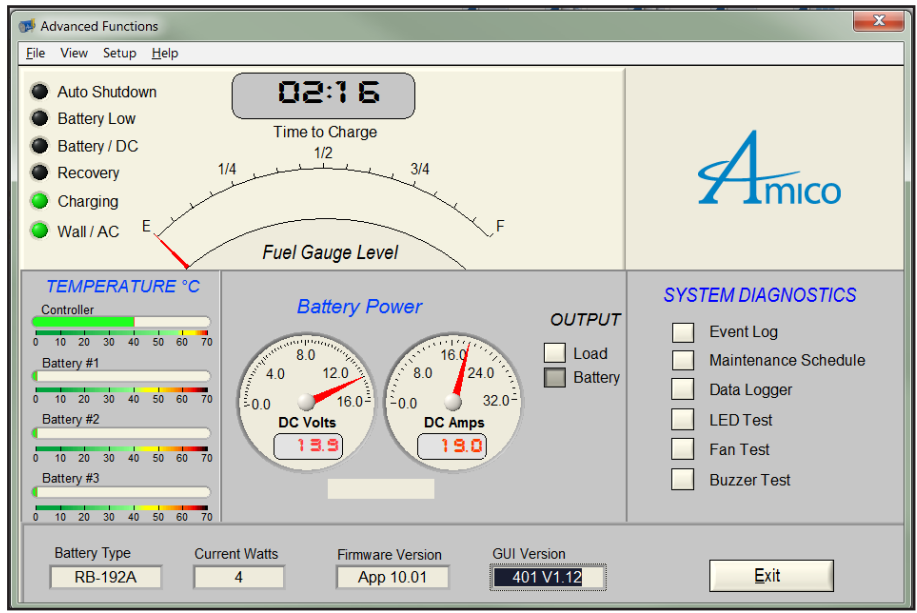

Advanced Functions Interface

Advanced Functions Description

This screen contains various system information, configurations and settings.

Pull Down Menus

There are four pull down menus (1) File, (2) View, (3) Setup and (4) Help. The File option provides an exit back to the Main Menu and the ability to terminate the software.

The Setup Option is described in earlier sections.

The Help Option provides information regarding the developer of the software, the current revision being used, and a quick access to the manual.

The View Option provides a summary view of the current state of the system.

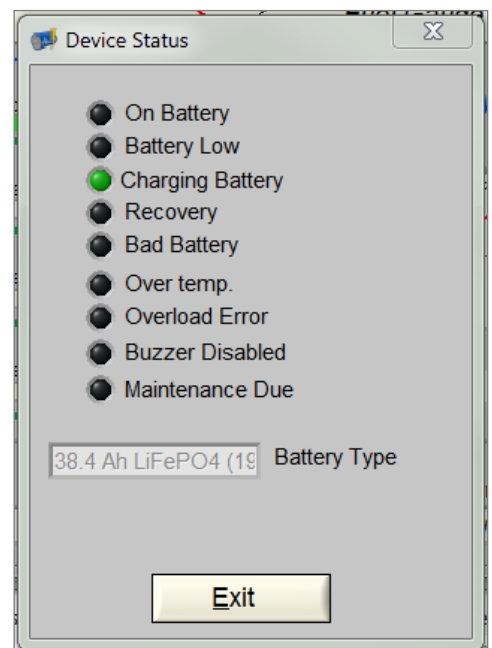

View Screen

Section 8: Field Diagnostics

Gauge and LED Indicators

The Gauge and LED Indicators are the same as found on the Main User's pop-up screen.

Thermal Sensors

There are up to four thermal sensors. The top most thermometer display is the ambient internal temperature of the Power System. The second, third and the optional fourth are the temperature of the respective posts of the 1st, 2nd, and 3rd battery [Battery #1, Battery #2, and Battery #3 respectively]. The sensors display the current temperature. If the temperature rises beyond the prescribed threshold, the bar will change color from green to red to indicate the increase. If the heat continues to rise beyond a further threshold, the system will automatically shut down, provide a warning pop up on the host CPU and provide an event describing system "overheat condition". Also, the Remote display will flash both the "recovery" LED and either AC or DC LEDs, depending on whether the system is charging or discharging, when an overheat condition is met.

Battery Power

DC Voltmeter

The DC voltmeter is used to display the Battery voltage in either charge or discharge state.

Amp Meter

The Amp Meter displays the current entering or exiting the battery.

Load Power

Load Meter

The Load Meter displays the combined total power being consumed in Watts.

AC Module Enable

This feature is available through the GUI with the Model 451 only. It may be used to disable the AC Output while leaving the DC outputs active. Switching off the AC Module saves approximately 1 Watt of quiescent power, and enhances system safety.

The AC Module output is enabled by default. If the 451 is completely powered off (disconnected from both AC and Battery sources), the AC Module remains disabled until it is re-enabled through the GUI.

When using this feature, be sure to enable the AC Module if there is an AC powered device connected to the system. The load current consumed by the AC power device is combined with the total Load meter display.

AC Module option will not be active with the 401 Series.

Section 8: Field Diagnostics

System Diagnostics

Events Log

This is a linked icon on the event pop up screen described in a later section.

Maintenance Schedule

This is a linked icon to the Maintenance pop up screen described in a later section.

Data Logger

This is a link to the Data Logger screen described elsewhere in this document.

LED Test

This provides an LED test for the user to quickly verify the operation of each LED. This test turns each LED on and off sequentially on the remote display.

Current Watts

This is the calculated estimate of the power, in watts, available in the battery.

Firmware Version

This is the current version of the device operational firmware.

GUI Version

This is the current version of the device graphical user interface version.

Battery Type

This is the battery model that was installed.

Exit

This icon returns control to the Main User's screen.

Section 8: Field Diagnostics

Event Log Screen

The Event Log function provides the user with a tabular view of the sequence of events experienced by the power system. Events depicted are items such as battery charge, low battery, shut down and a variety of others. Exit; this icon allows the user to terminate this screen and return to the Advanced Functions screen.

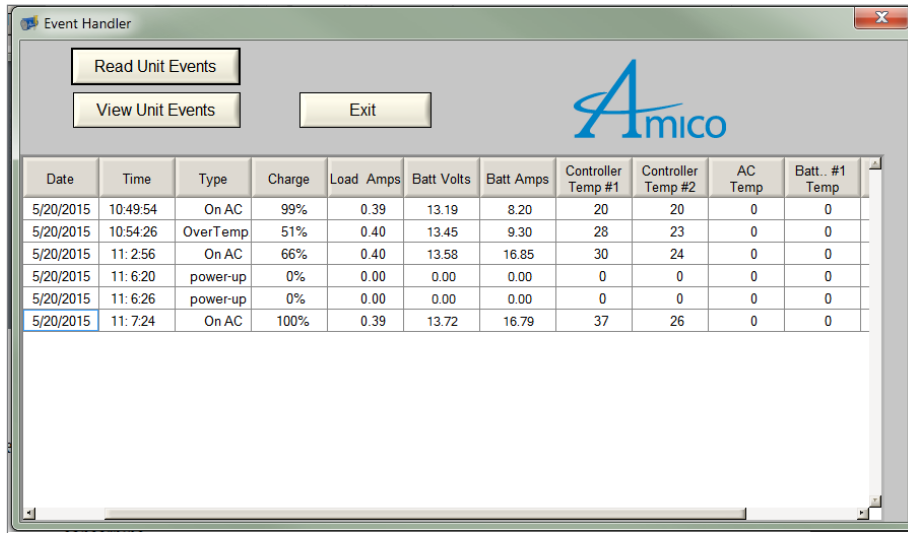

Event Log File

All of the events from the device are converted to ASCII text and then automatically saved to "Log_file.csv".

To save an Excel file, press "Read Unit Events." The default file location is the "400 Series" folder under Program Files. If the log file already exists, the data is appended to the file. If the file does not exist, the file is created and then the header is written before the function starts to read each of the events.

NOTE: To save the log for review, please ensure that you save it in a different folder from the default.

The event log file has a ".csv" extension allowing it to be loaded into Excel; a sample of which is shown below. To load data into the program, press "Load Unit Events" and then you will be prompted to select an Excel file on your computer or to load the data saved onto the power controller.

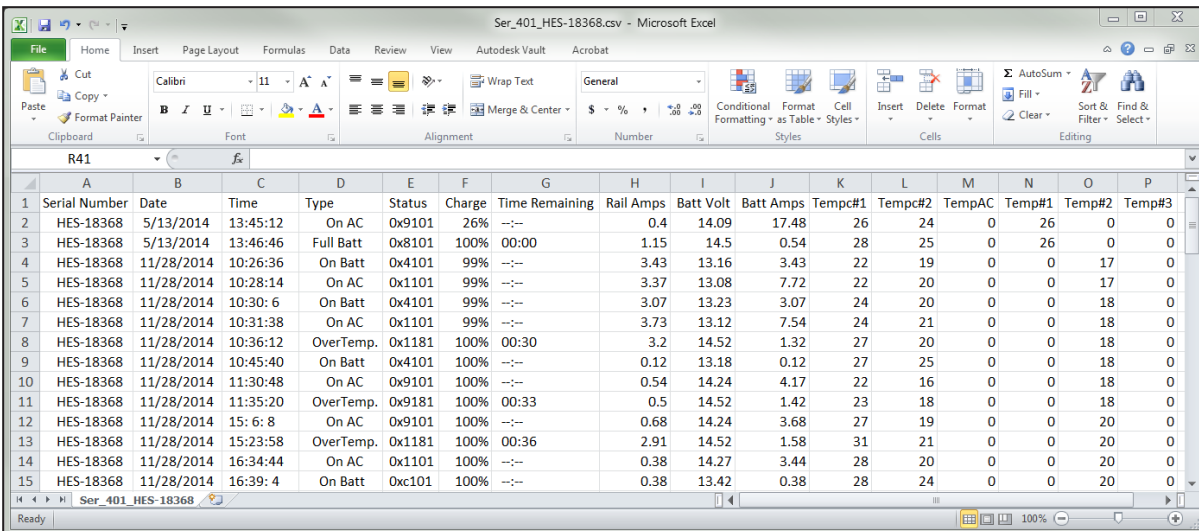

Sample of an Event Log loaded into Excel

Section 9: Maintenance

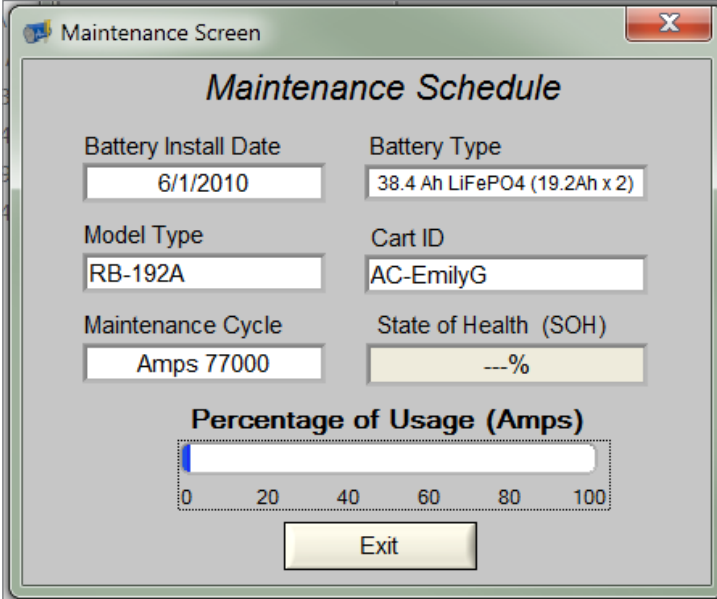

The screenshot shows a window titled "Maintenance Screen" with a close button (X) in the top right corner. The main content is titled "Maintenance Schedule" and contains the following fields:

Battery Install Date	Battery Type
6/1/2010	38.4 Ah LiFePO4 (19.2Ah x 2)
Model Type	Cart ID
RB-192A	AC-EmilyG
Maintenance Cycle	State of Health (SOH)
Amps 77000	---%

Below the fields is a bar graph titled "Percentage of Usage (Amps)" with a scale from 0 to 100. The bar is currently at 0%. Below the bar graph is an "Exit" button.

Maintenance Screen

This screen is an information screen and provides the technician with information of the last maintenance that was performed on the device.

The data on this screen is:

1. The date of the last service
2. The type of battery
3. The battery model installed
4. The Cart ID
5. The maintenance schedule event
6. A bar graph indicating age of the battery in weeks or amp hours
7. State of Health of the battery

Exit; this icon is used to exit the screen and return to the diagnostic screen.

Section 9: Maintenance

General Maintenance

The 400 Series system requires no calibration or periodic maintenance. Regular cleaning is not necessary if the fans can be kept clear of dust and debris. There are no materials consumed through operation. Product failure or product modification/update must be performed or authorized by Amico Accessories Inc. or its certified agent.

The end use system may require maintenance that may affect the 400 Series system; external fan cleaning for example.

There are no serviceable parts within the system except the coin cell battery. The system uses a replaceable Lithium coin cell battery to retain date information however; its longevity is theoretically >10 years based on the current draw required. The manufacturer's represented shelf life is 10 years however; therefore the battery may require replacement at approximately 10 years. The failure of the battery is non-critical. Replacement of this battery should be done by a trained technician or the product may be returned to Amico Accessories Inc.. The battery is a CR2032, lithium coin type battery.

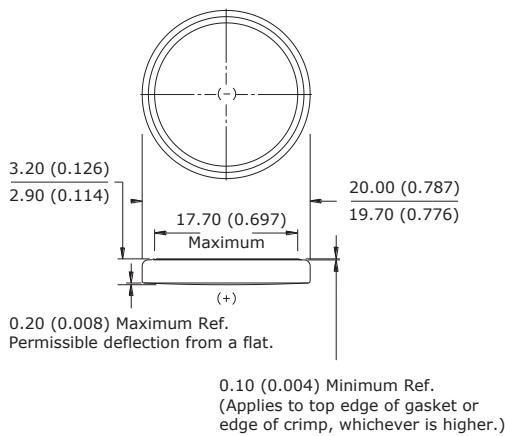

Classification: "Lithium Coin"
Chemical System: Lithium / Manganese Dioxide (Li/MnO₂)
Designation: ANSI / NEDA-5004LC, IEC-CR2032
Nominal Voltage: 3.0 Volts
Typical Capacity: 240 mAh (to 2.0 volts)
(Rated at 15K ohms at 21°C)
Typical Weight: 3.0 grams (0.10 oz.)
Typical Volume: 1.0 cubic centimeters (0.06 cubic inch)
Typical IR: 10,000 - 40,000 mΩ
Max Rev Charge: 1 microampere
Energy Density: 198 milliwatt hr/g, 653 milliwatt hr/cc
Typical Li Content: 0.109 grams (0.0038 oz.)
UL Recognized: MH29980
Operating Temp: -30C to 60C
Self Discharge: ~1% / year

Battery Maintenance

The main battery[s] will need to be replaced periodically as they lose their ability to be recharged. To accomplish this task please perform the following.

- Unplug the system from AC wall power
- On the Advanced Functions display, under the file pull down menu, choose the "software exit" selection
- Turn off the PC and all other devices powering the system
- Disconnect the battery[s] from their harness and remove from the system
- Reconnect new battery[s] to the respective harness
- Plug the system into the available AC wall power [it will have gone to sleep]
- Restart the devices including the PC
- Restart the 400 Series Software
- From the Main User screen, go to the Advanced Functions screen. On the Advance Functions screen, select the "Setup" pull down menu. Select the "400 Series Setup" choice. Update the battery information inclusive of the Battery Install Date. Activate the "Set & Send" button. All duration and battery information will be reset.

Section 10: Potential Hazards, Interference and Avoidance

There are no potential interference issues through normal usage. Potential hazards are limited to the use of standard AC connectivity. It is the responsibility of the Original Equipment Manufacturer [OEM] to install this product appropriately and to take precautions regarding the AC connectivity features and safe operator use. Refer to the Safety Precautions section of this manual.

There are no waste products or residue generated by this device.

The environmental conditions for transportation and storage are as generally commercially accepted; there are no unique or special concerns. Refer to the Technical Specification section of this manual for applicable Operating and Transportation environmental requirements.

Section 11: System Specifications

CLASSIFICATION	
"Type of protection against electrical shock"	Class I Equipment
"Degree of protection against electric shock"	Not classified- no applied parts
"Classification according to the degree of protection against ingress of water as detailed in the current edition of IEC 529"	"Ordinary protection only, IPX0. Not protected against ingress to moisture."
"Methods of sterilization or disinfection"	Part of end use equipment.
AP/APG Equipment	Not evaluated as AP/APG Equipment
Mode of operation	Suitable for continuous operation at rated load
IDENTIFICATION, MARKING AND DOCUMENTS	
"Marking on the outside of equipment or equipment parts"	"Reference following sections Component for use in end system application"
Protective packaging requirements	"The product is not inherently fragile beyond that of standard electronic equipment; however, care should be taken in protecting the container against damage that might affect electronic equipment. Shipping containers will have the following markings applied as required by the certifications. FRAGILE KEEP AWAY FROM RAIN The symbols will be applied with stencil or labels. The color shall be black. The location, size and frequency will be as described in the requirement document."
"Type of battery and mode of insertion"	"Approved Lithium coin Cell mounted in an approved coin cell holder. Not intended to be changed by the operator. Use of a tool required to access."
Indicator lights and push-buttons	"Red indicator LEDs are not used. Yellow LEDs indicate low battery level. Green LEDs are used to indicate mode of operation. No push buttons utilized."
EMC Certification	"Reference copy of TUV summary statement found directly after this table."
INPUT	
Voltage	100 to 240 VAC [tolerance $\pm 10\%$]
Frequency Range	50/60 Hertz
Power Factor Correction	0.96 to 0.98
Inrush Current (Typical)	30 A @ 100 VAC, 60 A @ 200 VAC
Current	6.5 AC Amperes maximum
INPUT/OUTPUT: DC BATTERY	
Voltage	3 to 15 VDC
Current	25 Amps DC Max (with <7 Amp Load Current)
Maximum Power	450 Watts max (with no load)

Section 11: System Specifications

OUTPUT: AC & DC LOAD	
DC Voltage	19.5, 12.0, 5.0
DC Current	10.0, 16.5, 2.0
AC Voltage	115 VAC nominal
AC Current	1.8 A max
Maximum Power	200 Watts Total Combined
OUTPUT: FAN	
Format	Variable Speed, Temperature Controlled
Voltage	0 - 13 V Variable
Current	750 mA DC Max Internally limited
OUTPUT: TEMP SENSORS	
Format	Digital Communication: I2C
INPUT/OUTPUT: USB	
Format	USB 2.0, slave, electrically isolated
OUTPUT: REMOTE DISPLAY	
Format	Digital communication; I2C
GENERAL	
Isolation: I/P to O/P	3000 VAC
I/P to Ground	1500 VAC
AC Line Input Efficiency	85% Typical
EMC	"TUV: IEC 60601-1-2:2007 + AC:2010 (Emissions& Immunity) AC output cable requirement specified in section 4.5. Contact Amico Accessories Inc. for additional information."
Testing Standards	"The product fulfills the requirements of : IEC 60601 1: 2005 + CORR. 1 (2006) + CORR. 2 (2007) EN 60601-1 : 2006 CSA C22.2 No. 60601-1: 2008 ANSI/AAMI ES 60601-1:2005 +C1:2009 +A2:2010 Contact Amico Accessories Inc. for additional information."
ENVIRONMENTAL	
Operating	10 to 40 degrees Celsius; 50 to 104 degrees Fahrenheit; requiring dual fans with adequate ventilation and airflow.
Transport/Storage	-25 to 85 degrees Celsius; -13 to 185 degrees Fahrenheit
Relative Humidity	0% to 93% non-condensing

Section 11: System Specifications

MECHANICAL	
Construction	Sheet Metal
Dimensions	[10.25" x 6.0" x 3.15"]
AC Input	4 position connector with latch
DC Output	8 position connector with latch
Fuse Holder	Mini Blade, 30 A
Fan Internal Connection	Polarized latching 3 pin
Fan External Connection	Polarized latching 2 pin (reference: Molex C-Grid SL Style)
Temp Sensors	Polarized latching 4 pin (reference: Molex C-Grid SL Style)
Remote Display [remote display]	RJ45
USB	USB Type B Standard
BATTERY PROFILES	
User Selectable	Reference GUI software or contact Amico Accessories Inc. for complete list.
FEATURES	
Intelligent Charging	Multistage charging algorithms in accordance with battery manufacturer's specifications. If over discharge is detected, auto switchover to deep discharge recovery mode.
Recovery	"Deeply discharged battery reconditioning controls the recovery of over discharged batteries to prevent SLA venting under normal charge conditions."
Dedicated Charging	"Full Amperage charging while simultaneously providing power to the load devices; 450 watts total power."
Auto Transfer	"Automatically transfers the load from the AC power to the battery when AC is removed."
"Intelligent Battery Monitoring (Algorithm Based)"	"DC Voltage, DC Current, Ambient Temp, Battery Temp, Total Charge/Discharge amp/hours since activation, User Selectable battery profiles."
Event Logging	"Captures the usage characteristics of Charge/Discharge cycles of the battery. Up to 2000 events can be logged and used for diagnostics and maintenance scheduling."
Remote Display [Remote display]	"True battery capacity, source of power, low battery, full charge, shut down warning, recovery mode."
Communications/software	"On screen software package, data retrieval software package, real time on screen monitoring via USB, intelligent shutdown of computer and attached peripherals, remote system diagnostics and email alerts to network administrator."
Thermal Safety	Thermal sensors provide shut down if the battery exceeds a temperature specified by the manufacturer as "abnormal". The default temperature is 50 degrees Celsius [or 122 degrees Fahrenheit].

Section 12: TUV Certification Statement

Contact Amico Accessories Inc. for further information.

Appendix A: Dimensional and Mounting Information

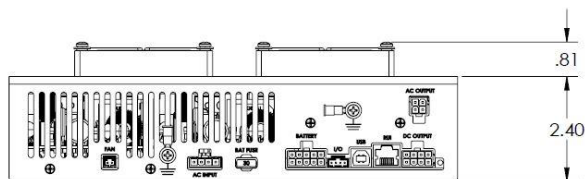
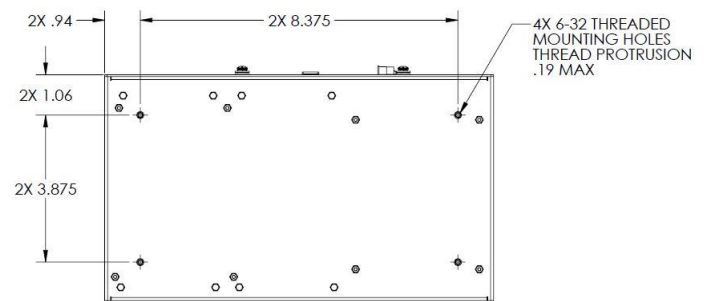
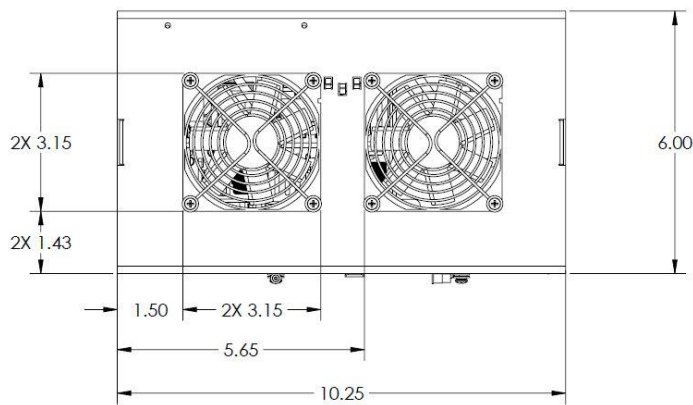

Dimensions

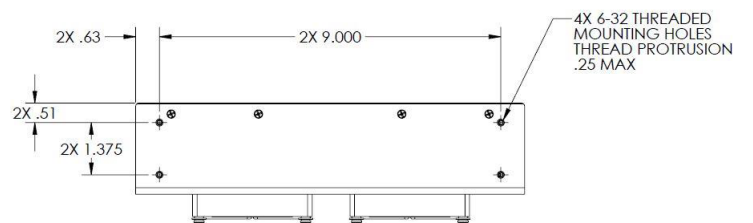

Mounting Information



Warranty Policy - Equipment Mounting Solutions

Amico Accessories Inc. warrants all mounting accessories to be free from defects in material and workmanship for a period of twelve (12) months from the date of shipment. Within this period Amico Accessories Inc. will repair or replace any part which is proven to be defective.

Amico Accessories Inc. will warrant its materials to be free from defect for an additional period of four (4) years, (five [5] years from the date of shipment). Within this period, Amico Accessories Inc. will replace any part which is proven to be defective, at no charge. Shipping and Installation costs after the first twelve (12) months will be borne by the Customer.

This warranty is valid only when the product has been properly installed according to Amico Accessories Inc. specifications, used in a normal manner and serviced according to factory recommendations. It does not cover products that are not manufactured by Amico Accessories Inc. It does not cover failures due to damage which occurs in shipments or failures which result from accidents, misuse, abuse, neglect, mishandling, alteration, misapplication or damage that may be attributable to acts of God.

Amico Accessories Inc. shall not be liable for incidental or consequential damages resulting from use of equipment.

All claims for warranty must first be approved by Amico Accessories Inc. A valid Return Goods Authorization (RGA) number must be obtained from Amico Accessories Inc. prior to commencement of any service work. Warranty work, which has not been pre-authorized by Amico Accessories Inc., will not be reimbursed.

AMICO ACCESSORIES INC. DOES NOT HONOR VERBAL STATEMENTS CONCERNING THE WARRANTY.

The distributor and/or dealer are not sanctioned to create verbal warranties about the product described in this agreement. Any statements will not be honored or be made part of the agreement of sale. This document is the final complete and exclusive terms of the agreement.

THIS WARRANTY IS INCLUSIVE AND REPLACES ALL OTHER WARRANTIES.

Amico Accessories Inc. shall not, under any circumstances be liable for incidental or consequential damages including, but not limited to, profit, loss of sales or injuries to person(s) or property. Correction of noncompliance as noted above will result in completion of all liabilities of Amico Accessories Inc., whether based on agreement, neglect or changed materials, designs or specifications without notice.

All claims for warranty must first be approved by Amico Accessories Inc. Service Department: accessories@amico.com or 1.877.264.2697). A valid Return Goods Authorization number must be obtained from Amico Accessories Inc. prior to commencement of any warranty claim.

www.amico.com

Amico Accessories Inc. | www.amico.com

85 Fulton Way, Richmond Hill
Ontario, L4B 2N4, Canada

71 East Industry Court, Deer Park
NY 11729, U.S.A.

Toll Free Tel: 1.877.264.2697
Toll Free Fax: 1.866.440.4986
Tel: 905.763.7778
Fax: 905.763.8587
Email: info@amico.com