

TECHNICAL DATA **rm-port**

Infrastructure

Length specifications and dimensions **rm-port**

Pivot arm **rm-port**, single, L = 250mm

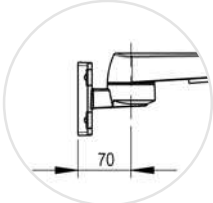

ITD extrusion

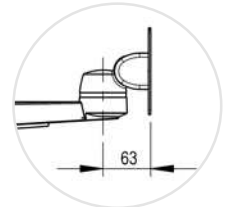
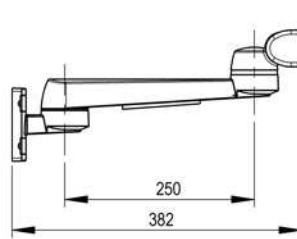

VESA 75 / 100 –
up to 18 kg / 39.6 lbs

Pivot arm **rm-port**, single, L = 325mm

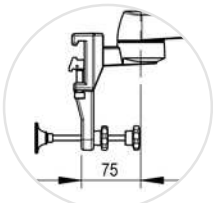

Standard runner
Regular mounting

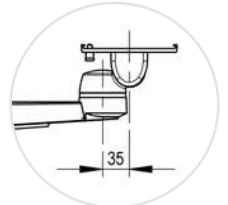
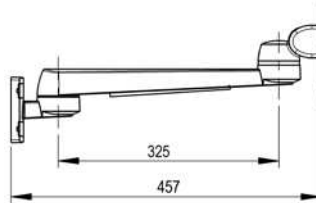

universal adapter –
up to 14 kg / 30.6 lbs

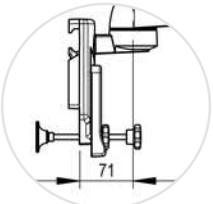

Standard runner
Rapid mounting

Pivot arm **rm-port**, double, L = 250mm + 250mm

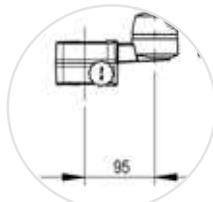

Pole Ø 35-38 mm

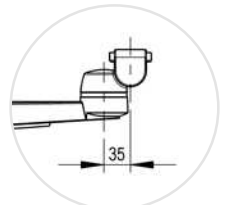
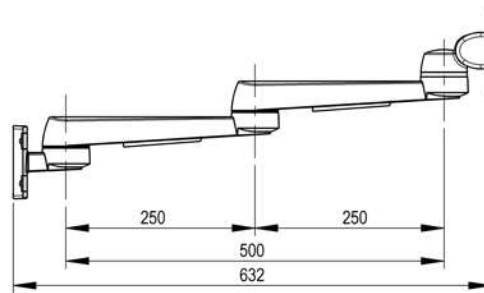
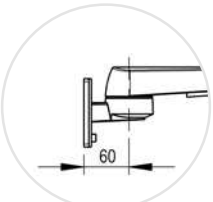
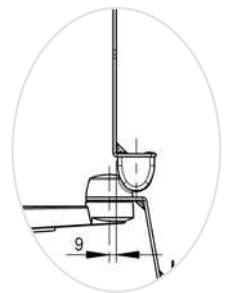
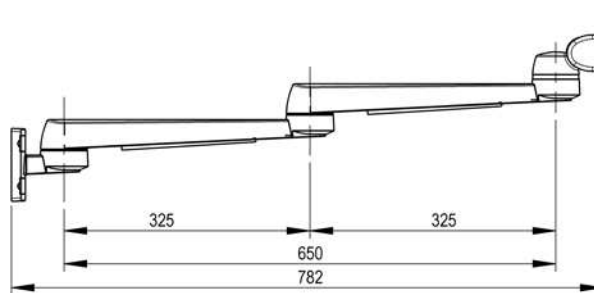

Table Top Mount-Adapter
up to 14 kg / 30.6 lbs
for Philips monitors



Channel GCX

Pivot arm **rm-port**, double, L = 325mm + 325mm



VESA 75 / 100, universal –
up to 14 kg / 30.6 lbs

TECHNICAL DATA **rm-port**

Adjustment range – Pivot arm **rm-port**, single

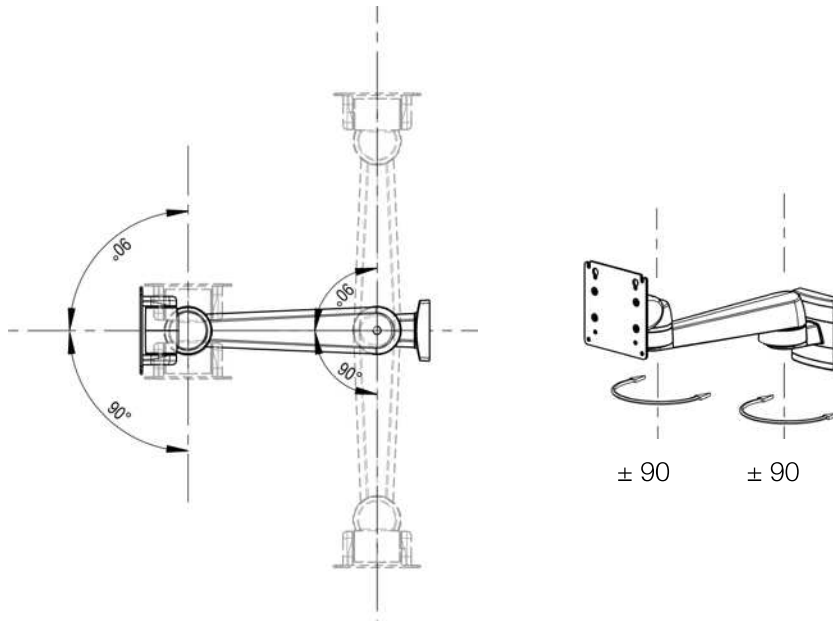

Adjustment range – Pivot arm **rm-port**, double

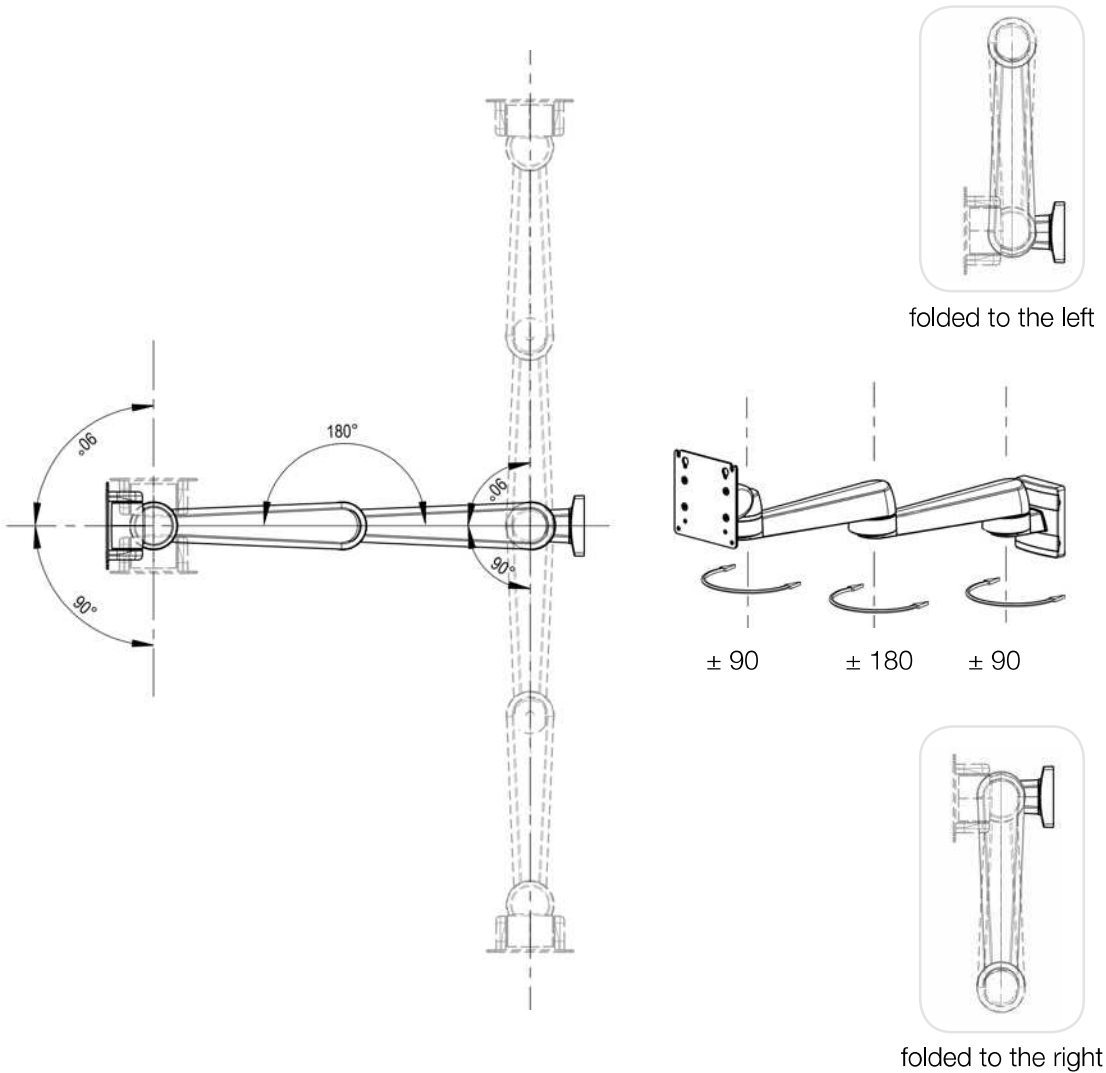

rm-port –
Pivot arms



ITD extrusion



Standard runner
Regular mounting

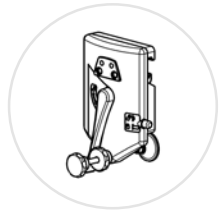

Standard runner
Rapid mounting



Pole Ø 35-38 mm



Channel GCX