

Ubiquitous Power Solution

UPower Pro-22

2-slot charger with 90W DC output

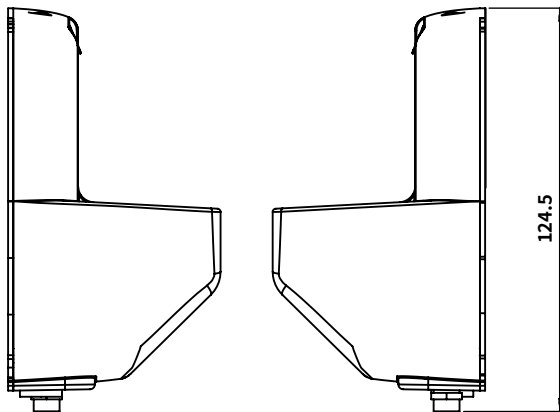
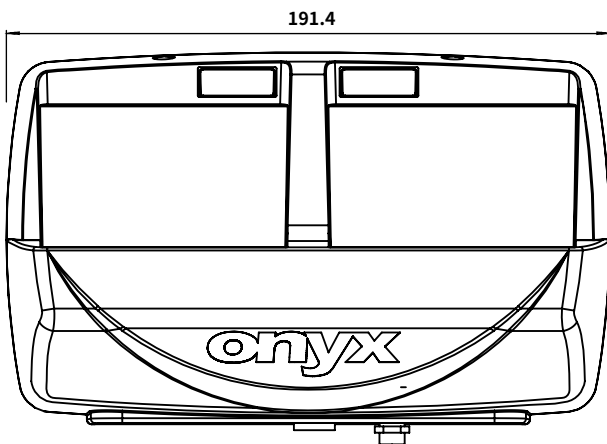

Features

- Compatible with short battery and long battery (XL)
- Max 90W power output, mini-din 4pin x1
- 10W USB port x1 (power output only)
- Selected voltage (12V / 19V / 24V)
- Non-stop, swappable batteries architecture
- Battery information monitor remotely (ORION)
- Support wall/cart mount. Fitting all environment
- LED indicator, clearly reveal recharge/discharge status

Specifications

Main Specifications

Output Voltage	12/19/24V (can be selected only one voltage)
Output Capacity	90W mini-din 4pin x1; 10W USB Type A x1 (power output only) *check user manual for more detail info
Battery Charge Time	3hrs for standard battery; 3.5hrs for XL battery
Input Power	24V Medical adaptor
Protection	Supports protection from over-voltage (input), over-current (input and output), short circuit, over-charge.
IO interface	Mini-din 4pin x1; USB Type A x1 (Power output only); USB micro-B x1 (Data transport only); DC-in
Certification	CE: EN 60601-1-2:2015(V4.0), EN 60601-1:2006/A1:2013(V3.1) FCC: Part 18 Class B UL: ANSI/AAMI ES60601-1:2012 (V3.1) cUL: CAN/CSA-C22.2 No. 60601-1:2014 (V3.1)

Mechanical and Environmental

Architecture	ABS + PC
Color	White
Dimension	191(L) x 64(W) x 117(H) mm
Net Weight	0.67kg (1.47 lbs)
Packing Size	390(L) x 290(W) x 110(H) mm
Gross Weight	2kg (4.41 lbs)
Operating Temperature	0°C ~ 35°C(32°F ~ 95°F)
Storage Temperature	-20°C ~ 60°C(-4°F ~ 140°F)
Storage Humidity	10%~95%@35°C, non-condensing

Battery LED Indicator

Blue Lighting	Full Charge (AC mode)
Blue Flashing	Charging (AC mode)
Green Lighting	Capacity 16%~100% (Battery mode)
Orange Lighting	Capacity 8%~15% (Battery mode)
Purple Lighting	Capacity 0%~7% (Battery mode)
Green-Purple Flashing	Charging error

Power Supply Specification

Input Voltage	100-240V AC @50-60 Hz
Output Power	24V / 6.25A

Battery Pack (optional)

Battery Type	6 / 9 / 12 Cell Lithium-ion battery
Battery Capacity	5700 / 8550 / 12060 mAh
Output Voltage	10.8 / 10.95 / 10.8 V

Ordering Information

- » UP-P22-A3-1010
2-slot Charger with DC output + 24V adaptor